



# COQUITLAM COLLEGE

*Established 1982*

**Emergency Response Manual**

**September 2025**

**Vancouver Campus: 300-2920 Virtual Way, Vancouver, BC.**

## Table of Contents

<b>Introduction</b> .....	4
<b>Coordination with Provincial Agencies</b> .....	4
<b>Response Procedures</b> .....	4
Responsibilities .....	4
Security (BTC) will: .....	4
Coquitlam College Incident Commander (President) will: .....	5
Fire Wardens .....	5
Chief Financial Officer and Human Resources .....	5
Student Services .....	6
Communications .....	6
Health and Wellness .....	6
First Aid Procedures .....	6
<b>Emergency Situations</b> .....	8
Alcohol and/or Drug Related Emergency .....	8
Assisting a person(s) with a disability during an evacuation .....	9
Bias/Hate Crime .....	9
Bomb Threat .....	10
Civil Disturbance or Demonstration .....	10
College Closure due to Severe Weather/Natural Disaster .....	11
Guidelines .....	11
Emergency or Delayed Campus Closing and Opening .....	11
Closing the Vancouver Campus for two days or less .....	11
Closing the Vancouver Campus for an extended period of time .....	12
Death of a Student or Staff .....	13
Suicide .....	13
Earthquake .....	14
Explosion .....	15
Fire .....	15
Flood .....	17
Harassment/Discrimination .....	17
Hazardous Substance .....	18
Information Breach/Disclosure .....	18
Lockdown .....	19
Medical Emergency .....	20
Missing Student .....	20
Power Failure .....	21
Public Health Emergency .....	21

Guidelines ..... 21

Psychological/Mental Health Emergency ..... 22

    Guidelines ..... 22

Sexual Assault ..... 24

Shelter-in-Place ..... 25

Suspicious Mail ..... 25

Terrorism/Active Threat..... 26

Violence ..... 27

    Guidelines for responding to violence: ..... 27

**Appendix A: Additional Resources**

- First Aid Attendants
- Critical Contact Directory
- Emergency Evacuation Map- 3<sup>rd</sup> floor
- Emergency Evacuation Map- 4<sup>th</sup> floor
- Emergency Evacuation Map- Ground floor
- Evacuation Assembly Point
- Communicable Disease Plan
- Hazardous Substances Emergency Procedures

**Appendix B: Coquitlam College Forms**

- Bomb Threat Form
- Incident Report
- Situation Report

**Appendix C: WorkSafeBC Forms**

- Worker’s Report of Injury or Occupational Disease to Employer
- Employer’s Report of Injury or Occupational Disease
- Employer’s Statement of Return to Work

**EVACUATION MAP WITH NEAREST EMERGENCY EXIT LOCATED ON THE FINAL PAGE OF THIS MANUAL.**

## **Introduction**

Coquitlam College (also Coquitlam College – Brookmere Secondary) Vancouver campus is located at 300-2920 Virtual Way in Vancouver, British Columbia in Building Six (6) at the Broadway Tech Centre (BTC). QuadReal+ Property Group owns the BTC buildings and facilities, and security operate under their jurisdiction. Coquitlam College reports issues and emergencies that affect the building to QuadReal+ Property.

## **Coordination with Provincial Agencies**

Throughout the response phase, Coquitlam College will maintain communication with the following provincial agencies:

- Ministry of Post-Secondary Education and Future Skills.
- Ministry of Education and Childcare.
- Ministry of Finance.
- Ministry of Emergency Management and Climate Readiness.

## **Response Procedures**

The response procedures outlined below align with the procedures provided by QuadReal+.

### **Responsibilities**

- Call 911 first, plus QuadReal+'s Security (BTC Security) at 604-834-0246.
- If appropriate activate the fire alarm.
- Try to confine the hazard by closing doors as you leave.
- Use proper personal protective equipment if you are providing medical treatment.
- Work with QuadReal+'s First Aid Response Team.
- Obtain and record information about the incident and individuals while maintaining your own safety and security.
- Keep information confidential.
- Notify the Senior Leadership Team and the President of the emergency.
- Secure your area and belongings as per appropriate emergency procedure(s).

### **Security (BTC) will:**

- Respond to scene as soon as possible and assist depending on the situation.
- Notify emergency responders and meet them at the building entrance, as necessary.
- Establish a security perimeter as necessary.
- Make a preliminary assessment if evacuation, shelter-in-place, or lockdown is indicated.
- Activate their EOC.
- Secure scene for emergency response personnel.

- Maintain confidentiality of all information.
- Support the local emergency responders, as necessary.
- Provide support and information to affected individuals as appropriate and available.
- Not allow anyone other than trained and equipped responders to enter the incident area.

#### Coquitlam College Incident Commander (President) will:

- Establish Incident Command (IC).
- Notify BTC Security immediately.
- Establish unified command with BTC Security if applicable.
- Assess the situation and determine appropriate actions in conjunction with QuadReal+.
- Prepare incident report.
- Conduct debriefing sessions with Coquitlam College staff and security.
- Conduct post-incident evaluation.
- Initiate corrective action and revise emergency plans as necessary.
- Take universal precautions whenever there is a potential for contact with blood or other potentially infectious material. Treat all blood and body fluids as infectious.
- Assist in isolating contaminated persons and do not allow them to leave or spread the contamination.
- Protect everyone from coming into contact with blood and body fluids.
- If providing medication treatment, use proper personal protective equipment. These are available with the first aid supplies.
- Not leave the patient alone.
- To the degree possible obtain and record information about the incident and individuals without creating any further risk.
- Keep all pertinent information confidential.
- Secure the area and belongings, as necessary.
- Try to confine the hazard(s).

#### Fire Wardens

- Assist evacuation, shelter-in-place, and lockdown on affected building or area as directed by Security.
- Ensure evacuees do not use elevators.
- Provide instructions to the community as indicated by the conditions and/or requested by QuadReal+, or Emergency Personnel.

#### Chief Financial Officer and Human Resources

- The Chief Financial Officer, backed up by the accounting department, will take the lead on this for students when dealing with financial affairs.

- The Chief Financial Officer, backed up by the accounting department and Human Resources, will take the lead on this for employees with dealing with financial affairs.

### Student Services

- Communicate with the parent, guardian, and/or next of kin and provide details in the following events and when necessary:
  - The student, instructional or non-instructional staff is required to be transported to a medical facility and treated.
  - The student, instructional or non-instructional staff has caused harm to themselves or another.
  - The student, instructional or non-instructional staff was arrested or taken into custody.
  - The student, instructional or non-instructional staff was responsible for vandalism or other destruction of property.
  - The student, instructional or non-instructional staff was operating a vehicle under the influence of alcohol or other drugs.
  - The student, instructional or non-instructional staff is deceased.

Student Services will maintain confidentiality and adhere to laws and regulations outlining individual privacy, PIPA, and freedom of information.

### Communications

- The Director of Marketing and Business Development will take the lead.
- All communication should be coordinated with Security (BTC).
- Alert Coquitlam College community via portals or email of the impending or present weather-related incident or natural disaster.
- Update Coquitlam College community of campus closure or emergency protocols if a natural disaster has occurred.
- Inform Coquitlam College community when an all-clear status is declared, and campus has resumed normal operations.
- If necessary, prepare official statement for any media inquiries.

### Health and Wellness

- Will determine which mental health supports are needed.
- Provide support and counselling to students, instructional and non-instructional staff.

### First Aid Procedures

- The First Aid room (including Dressing Station) is located on the 3<sup>rd</sup> floor, beside the elevators. The room is 'Hut 301'.
- The First Aid room has one (1) Intermediate First Aid kit (located in the stand-up cabinet). It also contains five (5) Basic First Aid kits, which are portable.

- There are lists of First Aid Attendants, their schedules, and their contact information posted at the First Aid room, the Staff Lounge area, and in the Academic Advising open office space.
- In the event of an emergency, First Aid Attendants are authorized to provide First Aid to the fullest extent of their training.
- In the event that a First Aid emergency is beyond the capability of the First Aid Attendant on-site, the First Aid Attendant will call 9-1-1 and have the employee transported via ambulance to the nearest hospital.
- Any First Aid provided will be documented by the First Aid Attendant (using First Aid Reporting forms, accessible in the First Aid room).

## Emergency Situations

### Alcohol and/or Drug Related Emergency

Alcohol or drug overdose is a medical emergency. Alcohol poisoning can be fatal. Drug overdoses (prescription and illegal) may result in death. Individuals who appear under the influence of alcohol or drugs may exhibit symptoms which include the following:

- Loss of motor control.
- Disorientation.
- Slurred speech.
- Slow, shallow breathing.
- Clammy, cold skin.
- Appear bluish or pale.
- Vomiting/Nausea.
- Agitation.
- Unconsciousness.

If a member of the College community is suspected of being impaired and/or experiencing a medical emergency related to drugs or alcohol, the matter will be reported to the President or Designate immediately. If the individual's immediate health or safety is at risk, an ambulance will be called immediately. Otherwise, the person will be sent home in college paid transportation.

Nasal Narcan is available in the First Aid Room (Hut 301). In the event of a suspected overdose, the nearest person should treat the affected person with the nasal Narcan while someone else calls 911.

### Assisting a person(s) with a disability during an evacuation

In the event that a member of the College community with a disability is having difficulty evacuating during an emergency, the nearest Staff or Faculty should ask if they require assistance. If the person indicates they do require assistance:

- Allow the person to identify how best to assist them.
- Do not touch the person, their service animal, or their assistive device/equipment without their permission.
- Avoid attempts to lift, support, or assist in moving someone unless you are familiar with safe techniques.
- If possible, take or direct the person to the evacuation assembly location.
- Elevators cannot be used during an emergency evacuation. Unless there is imminent danger, untrained people should avoid evacuating a person who cannot get out of their wheelchair.
- Assist the person to move to a stairwell and contact BTC Security at 604-834-0246. Inform them of the situation, and your location.
- Security will immediately inform Emergency Services of the situation, and they will decide if it is necessary to evacuate the person needing assistance. In cases where there is a fire alarm, the cause of the alarm may be false or in a distant location, therefore evacuation may not be required.

### Bias/Hate Crime

According to the Criminal Code of Canada, Section 319:

*Everyone who, by communicating statements in any public place, incites hatred against any identifiable group where such incitement is likely to lead to a breach of the peace is guilty of an indictable offence and is liable to imprisonment for a term not exceeding two years, or an offence punishable on summary conviction.*

Any action that could be construed as, or lead to a bias/hate crime taking place should be reported to BTC Security at 604-834-0246 & the President or Designate immediately.

All bias and hate crimes will be reported to the Vancouver Police Department or RCMP.

## Bomb Threat

Anyone may be the recipient of a bomb threat via telephone. If you receive a bomb threat by telephone:

- Stay calm and speak to the caller with a pleasant tone.
- Let the caller know you are willing to cooperate by listening to what they have to say.
- Ask the caller if there is anything you can do to help.
- DO NOT upset the caller.
- Keep the caller on the line- use the [Bomb Threat Form](#) in [Appendix B](#) to gain as much information as possible.
- Take notes on everything said and on your observation about background noise, voice characteristics, language, etc.
- Record the phone number and the time which the call was received.

Call 911 and BTC Security at 604-834-0246 as soon as the call has ended. If possible, get a co-worker to call emergency personnel while you continue talking to the caller. Whoever calls 911 or Security should not hang up until they are released by the authority talking to them. Inform the President or Designate as soon as possible.

The fire alarm should not be activated to evacuate the building as this may cause unnecessary panic or detonate the bomb. Survey the immediate work area- if you see a suspicious package or foreign object, DO NOT touch it. Calmly move away from the object and instruct others to follow slowly.

Do not spread word of the threat, as it may incite panic. Wait until Emergency Personnel, the President or Designate, or a QuadReal+ Representative instruct everyone to evacuate before calmly proceeding outside. The instructions will be relayed over the school's paging system.

## Civil Disturbance or Demonstration

Demonstrations are not permitted within the building as they may interfere with business operations for other tenants. Individuals seeking to exercise their right to assemble can do so on city sidewalks outside the building.

In the event of a disturbance when an individual or group refuses to leave the building, BTC Security should be phoned at 604-834-0246, and the President or Designate informed as soon as possible.

## College Closure due to Severe Weather/Natural Disaster

This applies to the following:

- Blizzard.
- Flooding.
- Hail.
- Heavy Rain.
- Ice.
- Sleet.
- Snowstorm.
- Thunderstorm.
- Coastal Storm.
- Other severe weather events.

### Guidelines

The Senior Leadership Team will monitor the forecast and warnings for weather and road conditions from different sources, including Environment Canada, local media outlets, etc. Security (BTC) will make recommendations with respect to emergency closing. Before making an independent decision to close the campus, Coquitlam College will contact Security (BTC) for their assessment of the situation and with respect to the emergency closing.

If there is inclement weather forecasted that may cause the College to close, the President or Designate will decide on whether to close the college campuses and properties and communicate this decision no later than 7:00am (07:00) for morning/daylong closures, 11:30 am (11:30) for afternoon closures, and 3:30 pm (15:30) for evening closures.

The following are issued by Environment Canada

- Advisory – issued when a less serious event is expected or imminent within 12 hours.
- Watch – issued for specific areas when the potential exists for an event to occur within 36 hours or less.
- Warning – issued for specific areas 24 hours or less before anticipated effects from an event is strongly expected or is imminent.

### Emergency or Delayed Campus Closing and Opening

Emergency Closing decisions will be made by the President or Designate in consultation with QuadReal+ and will be communicated to the College community via CC Broadcast, Email, and on the College website.

### Closing the Vancouver Campus for two days or less

- Inform the College community using all available communication tools.

- Missed classes will be made up within reasonable time.
- Evacuate the building.
- Affix temporary signage to entry points on the third and fourth floor.
- Contact Security (BTC) to lock doors to classrooms and offices.

#### Closing the Vancouver Campus for an extended period of time

- Inform the College community using all available communication tools.
- Move to online delivery as appropriate.
- Inform Security (BTC).
- Evacuate the building.
- Affix signage to entry points of the campus.

In cases of cancellation or closure, the College will align procedures with the policy [1.4.7. College Closures](#).

### Death of a Student or Staff

In the event of the death of a student or staff, the response will be handled by the Senior Leadership Team. The President or Designate should be informed immediately, and they will be responsible for contacting Emergency Personnel.

If the death occurred on campus, BTC Security and the Senior Leadership team must be notified immediately. The scene will be secured, and all relevant Emergency Personnel called. If the death occurred during an off-site College organized activity, a staff member accompanying the trip should immediately call 9-1-1, and then the President or Designate. If the deceased is the sole staff member accompanying the trip, one student should call 9-1-1 while another contacts the main college reception at 604-939-6633.

Initial communication to the immediate family is the responsibility of the Police or RCMP. The College will not release any information prematurely to respect this process and family members of the deceased. Once it has been confirmed that the decedents family has been notified, the President or Designate will communicate the loss to the College community, adhering to the family's wishes in terms of information disclosed, and instructions from local law enforcement.

The College will arrange for support services for both students and staff for the period immediately following the loss. This may include on-site individual counseling, providing group de-briefings sessions, contacting the Employee Family Assistance Program (EFAP), or other actions as deemed appropriate.

All communications (internal and external) must be approved by the President or Designate and should be conducted by the Senior Leadership Team.

### Suicide

In the event of a death by suicide, other members of the College community may be at an increased risk of suicide. In addition to general counseling services, the Health and Wellness Services may reach out to students or staff known to be at risk. These could include individuals close to the deceased and those who are already vulnerable to depression and/or suicidal ideation.

Any staff or student who believes someone is at a risk of self-harm should contact Health & Wellness Services immediately.

## Earthquake

In the event of an Earthquake, Drop, Cover, and Hold on:

- Drop to the ground.
- Take cover by getting under a sturdy desk or table.
- Hold on to the desk or table until the shaking stops.

If there is no appropriate desk or table to get under, move into a hallway or along an inside wall. Do not brace in a doorway. Move as far away as possible from windows, glass doors, or other heavy furniture. Cover your head and neck area with your arms to protect them from debris.

Once the shaking has stopped, count to 60 seconds before moving. Once you do, move slowly and carefully, checking for any hazards above or around you.

**If there are no visible signs of damage to the building:**

Stay where you are and wait for further instructions. The President or Designate will contact QuadReal+ to determine if evacuation has been deemed necessary. If an evacuation has been deemed necessary, the school paging system will be used to announce that everyone needs to leave via their nearest emergency exit.

If you smell gas or rotten eggs, immediately evacuate the building and once outside, call 911. Have someone else call BTC Security at 604-834-0246 and report where the smell was strongest.

**If there are visible signs of damage to the building:**

Calmly proceed to your nearest emergency exit. Be prepared that aftershocks may occur, and you may be required to Drop, Cover, and Hold On again. Do not use the elevators. Re-enter the building only once Emergency Personnel, the President or Designate, or a QuadReal+ Representative have instructed it is safe to do so.

Do not call 911 to report the earthquake, or other non-emergency lines. Only call 911 if there is a genuine risk to life.

Do not leave the evacuation area until you have spoken to your Instructor/Supervisor. If you are unaccounted for, the assumption will be made you are still inside the building, and Emergency Personnel will keep searching for you. It may also not be safe for you to leave the area.

## Explosion

In the event of an explosion:

- Immediately take cover under tables, desks, and other objects, which will give protection against falling/flying glass or debris.
- Be prepared for further explosions- stay away from windows, mirrors, glass, overhead fixtures, filing cabinets, bookcases, and electrical equipment.
- After the initial effects of the explosion and/or fire have subsided, call BTC Security at 604-834-0246. Give your name and describe the location and nature of the emergency.
- Be sure to notify Security of any special hazards, like gas leaks and power failures.
- Unless instructed otherwise, stay where you are.
- If the explosion threatens you or others, or if you are instructed to do so, evacuate the building.
- Pull the fire alarm if you pass one on your way out of the building.
- Calmly proceed to the nearest marked exit and proceed to the College's evacuation assembly location.

## Fire

If you observe smoke or fire:

- Remain calm.
- Immediately leave the building via the nearest clear emergency exit. Do not use the elevators.
- Those who are unable to evacuate the building, such as people with physical disabilities should move to a stairwell and contact BTC Security at 604-834-0246. Inform them of your situation and location.
- Pull the fire alarm if you pass one on your way out of the building.
- As you are leaving the building, encourage others to evacuate as well.
- Proceed immediately to the evacuation assembly location.
- Once outside, contact BTC Security at 604-834-0246 and inform them of the situation and location.
- Re-enter the building only once Emergency Personnel, the President or Designate, or a QuadReal+ Representative have instructed it is safe to do so.

If you cannot leave the building:

- Remain calm.
- Use the back of your hand to feel closed doors. Do not open if they feel hot.

- Use a wet cloth to seal cracks under the door and cover air vents. Call BTC Security at 604-834-0246 and inform them of the situation and your location.

### Use of a Fire Extinguisher

In the case of a small fire (a fire in the early stages), a fire extinguisher can be used only if the following conditions are met:

- You have been properly trained.
- You are capable and willing to use the extinguisher.
- A fully charged extinguisher is available.
- The fire has already been reported.
- You can fight the fire safely.
- You have a clear exit path behind you.

The portable fire extinguishers on campus are rated ABC which means they are designed to suppress class A (paper/wood/cloth), class B (flammable liquids and gases), and class C (electrical) fires. They contain a dry powder extinguishing agent.

If you choose to fight a small fire with a portable fire extinguisher, remember the following steps:

- Grab the fire extinguisher; if it is in a cabinet with a glass window, use a heavy object to break the glass. **DO NOT USE YOUR BARE HAND.**
- Remember PASS:
  - P – Pull the pin out (on the extinguisher handle).
  - A – Aim the nozzle at the base of the fire.
  - S – Squeeze the handle to discharge the extinguishing agent.
  - S – Sweep the nozzle back and forth at the base of the fire.

When the fire pull is pulled the alarm goes off in the entire building; however, on the floor where the fire pull is activated the alarm sounds in full on that floor as well as one floor above and one floor below. In the rest of the building the alarm is slow paced as a warning.

## Flood

In the event of an unexpected (flash) flood:

- Remain calm.
- Be prepared to evacuate but remain in the building until instructed to do otherwise by Emergency Personnel, the President or Designate, or a QuadReal+ Representative.
- If outside, seek shelter indoors and/or on higher ground.
- Avoid walking or driving through standing water, as depth and current are difficult to gauge.
- Be aware of the potential for electric shock if water has come into contact with any electrical cords or devices.

## Harassment/Discrimination

Harassment on the basis of race, sex, religion, or any other protected class, evidenced by persistent words, conduct or actions directed at an individual that badger, annoy, threaten, or cause substantial emotional distress, is strictly prohibited at Coquitlam College. Slurs and other verbal/nonverbal or physical conduct directed to an individual because of membership in a protected class is considered to constitute harassment when this conduct:

- Has the purpose or effect of creating an intimidating, hostile or offensive working or school environment.
- Has the purpose or effect of unreasonably interfering with an individual's work or student's performance in school including performance in curricular, extracurricular, and non-academic activities.
- Otherwise adversely affects an individual's employment or a student's opportunities in curricular, extra-curricular, and non-academic activities.

Any action that could be construed as Harassment or Discrimination should be reported to Human Resources & the President or Designate immediately.

Coquitlam College supports academic freedom and does not intend this policy to prevent or limit discussion of ideas, taboos, behaviour, or language as an essential element of course content, even if opinions and ideas expressed cause some discomfort.

## Hazardous Substance

In the event of a minor release of a hazardous substance (less than or equal to 4 litres), when there is no immediate health risk or contamination to the body, trained staff members will use substance appropriate materials and equipment to clean up the area.

If there is a major release of a hazardous substance that presents an imminent threat to health and safety, all staff and students should evacuate the building and activate the fire alarm. Once outside, staff will call 9-1-1, providing as much detail as possible regarding the hazardous substance release.

Further information can be found in [Appendix A: Hazardous Substances Emergency Procedures](#).

## Information Breach/Disclosure

Information breach/disclosure occurs when privilege or confidential information is intentionally or unintentionally released to unauthorised parties, or when such information is obtained by unauthorized parties through improper or illegal means.

Upon receiving notification of an information breach or disclosure occurring because of technological misuse/malfunction, the IT department (in consultation with LogicITy) will assess the situation and diagnose the problem. If an information breach is identified, the IT department will take immediate corrective action, as necessary.

In the event of an information breach or disclosure that is not related to technological misuse/malfunction, the President or Designate should be informed of the breach immediately. All appropriate action will be taken to contain and minimize the effect of any unauthorized information release.

## Lockdown

An emergency or threat may require the College to lockdown some or all of the buildings on campus. This is a way to prevent movement and access in areas near immediate danger.

In the event that Lockdown procedures need to be activated:

- The College community will be notified through the school paging system.
- Remain calm.
- **DO NOT PULL THE FIRE ALARM.**
- Close blinds/curtains.
- Turn off lights and computer monitors.
- Put cell phones on silent.
- Stay away from doors and windows.
- Restrict movement in the room.
- If you are in an area that does not lock, use all available items, furniture, and equipment to barricade entry.
- Stay low to the floor and under a desk or bed, if possible.
- Do not leave the area until instructed by BTC Security, the President or Designate, and/or authorized emergency response personnel.

**A fire alarm will never be pulled to evacuate a building during lockdown.**

An example of when a “Lockdown” instruction would be given: a dangerous person is engaging in violent behavior in the building. People that are not in the immediate vicinity of that dangerous person may be given lockdown instructions. This limits injury by reducing unnecessary movement and controls the environment to allow law enforcement to respond.

Only leave your area when instructed by Emergency Personnel, the President or Designate, or a QuadReal+ representative.

## Medical Emergency

If a Medical Emergency occurs:

- Remain calm.
- Assess the severity of the situation. There is a list of [First Aid Attendants in Appendix A: First Aid Attendants](#).
- If the situation is beyond minor First Aid, call 911. Additionally, alert BTC Security at 604-834-0246.
- If possible, ask a bystander to go to the lobby or building entrance and direct emergency responders to your location.
- Stay with the person until emergency responders arrive.
- Do not move the person unless they are in immediate danger.
- If trained and willing to do so, administer CPR and use an AED if necessary.
- There is one AED on the 3<sup>rd</sup> floor, located in the First Aid Room, beside the elevators. The room is 'Hut 301'. There is another AED on the ground floor of BTC Building 6, off the main lobby. Operating instructions are provided on each AED.
- Following a Medical Emergency, a First Aid Record and an Incident Report must be filled out. Incident Report forms are available in [Appendix B: Incident Report](#). Incident Reports must be submitted to the President or Designate. First Aid Reporting forms are available in the First Aid Room.

If the medical emergency is the result of a physical assault, the incident must be reported to local law enforcement. In the case of an employee being injured at the College, all applicable WorkSafeBC forms must be completed.

## Missing Student

If a member of the College community has reason to believe or has received a report that a student might be missing, the matter will be reported to Student Services who will notify the President or Designate immediately.

Attempts will be made to contact the student via email, phone, text, etc. If a student has not responded within 24 hours, the student's emergency contacts will be notified, and the Vancouver Police Department will be contacted to do a wellness check at the student's residence. In the event an abduction is witnessed, the appropriate Police Department will be notified immediately.

If the student is still not found, the College will take further direction from the Police and/or other law enforcement agencies on procedure and co-operate fully with any investigation.

All inquiries from the media and external community regarding the student's disappearance should be directed to the President or Designate.

### Power Failure

In case of a power failure, the emergency lights will operate, but there will be limited elevator service. BTC Security & the Facilities Manager will investigate and communicate the expected length of the outage. If power will be interrupted for a lengthy period, an evacuation order may be issued by QuadReal+. Information updates from QuadReal+ will be communicated through the building public address system.

### Public Health Emergency

A public health emergency includes a case or outbreak that may involve infectious diseases such as the following:

- Avian flu and other influenza.
- Measles.
- Methicillin-resistant *Staphylococcus aureus* (MRSA).
- Mumps.
- SARS.
- Covid-19.

### Guidelines

Typically, it is not necessary to inform the entire College community or Security (BTC) about a single infectious disease case. Disclosure and confidentiality of patient information must follow provincial and federal laws.

Anyone suspected of having an infectious disease should be referred to their primary physician, or to an appropriate health treatment facility. Students with an infectious disease should not attend school. When a case of infectious disease occurs on campus, this incident should not be considered a reason for school closure, except in the event of an emergency. When an outbreak or an increase in infectious disease occurs within the College community, the College will contact the local health authority.

Individuals suspected of being infected with a reportable infectious disease for which isolation is required should be refused admittance to the campus while acute symptoms are present. Students, instructional and non-instructional notifications should be based on consultation with the local health authority and QuadReal+.

Further information can be found in [Appendix A: Communicable Disease Plan](#).

## Psychological/Mental Health Emergency

A psychological emergency is a situation in which someone is experiencing extreme duress, is unable to cope with everyday life, or is in danger of hurting oneself or others. The following behaviours may be present:

- Paranoia.
- Hysteria.
- Confusion.
- Agitation.
- Anxiety.
- Uncontrolled anger.
- Delusions/Hallucinations.
- Disruptive Behaviour.

## Guidelines

When dealing with individuals displaying erratic or irrational behaviour that might cause harm to oneself or other, do the following:

- Stay calm and speak slowly and clearly. Do not argue with, confront, or challenge the person, or tell them to calm down.
- Take the person seriously and express a desire to help. Ask how you can help resolve the situation and repeat their words back to them to confirm understanding.
- Try to use simple language, and short sentences. Avoid interrupting the person, and don't react if they interrupt you.
- Be empathetic. Try to understand where the agitation is coming from- someone may be yelling because they feel they are being ignored. If you clearly communicate you are listening, they may lower their voice.
- Keep your body language neutral. Look attentive, but don't make excessive eye contact. Keep your hands low, and where the other person can see. If possible, ask if they would care to sit. If they agree, sit with them (stay at the same level), a minimum of an arms length away. Stay out of range of being grabbed or kicked.
- Re-direction can reduce tension- ask if they would like some water, tea, etc.
- Always make sure you have at least one clear path to an exit. Remember, an exit may be behind you.
- Never turn your back on someone who is exhibiting agitation or hostility. Keep your focus on them until the situation has fully de-escalated, or help has arrived.

Mental Health Crisis Support is available for employees through Sparrow, the Employee Family Assistance Program. Call [1-866-644-6881](tel:1-866-644-6881) for 24/7 crisis support.

If you cannot safely de-escalate, slowly move towards the closest exit, or where other people congregate. If you can, alert another employee to call for help.

**DO NOT TOUCH/RESTRAIN** the person, unless they require immediate medical attention, and it is safe for you to do so. Unless you have received thorough training in how to safely restrain someone, you are very likely to injure both yourself and the person being restrained. Instead, slowly move yourself and any other people near you to a safe space, lock or bar the door, then alert BTC Security and call 9-1-1.

## Sexual Assault

Criminal Code of Canada, Section 271, 272, and 273 covers sexual assault. Sexual assault refers to non-consensual sexual contact, which can range from unwanted groping or kissing to engaging in sexual activities with someone underage, asleep, unconscious, or simply unwilling.

Confidentiality must be provided to both the victim and the accused to the extent consistent with protecting the greater good of the College community and complying with local, provincial, and federal laws and reporting requirements.

Underage students at Coquitlam College and Coquitlam College – Brookmere Secondary must have a separate plan and process for sexual assault. This is addressed in the College's [Child Abuse and Protection Policy](#).

Primary Response Team:

- Call 911 and Security (BTC).

Secondary Response Team:

- Office of the President.
- Office of Health and Wellness.
- Office of Student Services.
- Office of Human Resources.
- Office of the Registrar.
- Office of Marketing Department.

Follow-up:

- Encourage a follow-up medical exam if an assault or sexual assault has occurred.
- Encourage follow-up counseling on or off campus.
- Ensure judicial follow up occurs according to Coquitlam College's [Student Non Academic Conduct Policy](#).

Provide appropriate follow-up with the College community, including addressing community concerns, information sharing, and other necessary support services.

For further information regarding Coquitlam College's policies and procedures regarding Sexual Assault, please refer to the College's [Sexual Misconduct Policy](#).

## Shelter-in-Place

Shelter-in-Place is a temporary strategy designed to be used when it is safer to remain inside rather than evacuate to the outside. Sheltering can be employed when there is a release of hazardous substance(s), or an emergency weather event. Ideal shelter areas are any interior rooms away from windows and doors that are above the ground floor and have a minimal number of vents and doors that can be closed or sealed.

While Shelter-in-Place is similar to Lockdown, it is given for different reasons. For example, a Shelter-in-Place may be implemented for a severe weather warning where it would be unsafe for people to be outside but does not require people to follow Lockdown procedures.

The fire alarm should not be activated as this may confuse building occupants and cause some to evacuate outside.

## Suspicious Mail

Anyone may be the recipient of suspicious mail or package. A suspicious object may contain the following characteristics:

- Unexpected delivery, foreign mail, air mail and/or special delivery.
- Misspellings of common words.
- Restrictive markings such as “Personal” and/or “Confidential”.
- Titles but no names.
- Protruding wires or foil.
- Lack of a return address.
- Excessive weight.
- Oily stains or discolorations.
- Visual distractions.
- Lopsided or uneven writing.
- Strange odors.
- Leaking powdery substance.
- Excessive amount of securing material used (tape, string, etc.).
- Strange sounds.

The recipient of a suspicious mail item should:

- Immediately call BTC Security at 604-834-0246. They will determine if 911 should be called.
- Not handle, shake, smell or taste the suspicious item.
- Isolate the article and evacuate the immediate vicinity.
- Advise anyone who has handled the article to immediately wash their hands with soap and water.

## Terrorism/Active Threat

Active Threat/Terrorism is violence or the threat of force or violence against person(s) or property for purposes of intimidation, coercion, or ransom. Terrorists use threats or violent acts to create fear among the public and to obtain immediate publicity for their cause(s). Terrorist events can occur on campus or off campus. Terrorism can take many forms including:

- Active Threat.
- Arson and Fire bombings.
- Bomb threats (see Bomb Threat section).
- Biological hazard.
- Chemical.
- Cyberterrorism.
- Explosions.
- Hijackings.
- Kidnapping and Hostage-takings.
- Nuclear.
- Radiological.
- Suspicious packages.

If an act of Terrorism occurs:

- Remain calm and patient.
- The President or Designate will consult with QuadReal+ to determine if an evacuation is required. Remain where you are but be prepared to evacuate.
- Do not leave the building/area without informing your Supervisor or the President. It is instinctual to want to secure your family during a crisis, but the College must be able to account for the whereabouts of all employee's during an emergency. It also may not be safe for you to leave the area.

## Violence

If you are victim of violence or see someone else being attacked, call BTC Security at 604-834-0246 immediately, then call 911.

Any act of violence or threatening behaviour is unacceptable and will not be tolerated

Examples of violence can include:

- Undesirable behaviour.
- Possession of a weapon.
- Sexual harassment.
- Telephone harassment.
- Theft.
- Trespassing.
- Vandalism.

### Guidelines for responding to violence:

If possible, get to a place of safety, then lock or bar the door. Contact BTC Security at 604-834-0246, then call 911.

If you cannot get to a place of safety and must deal engage with a threatening person on campus, **DO**:

- Try to calm the individual.
- Listen and let them do the talking.
- Try to delay any related negative decisions.
- Acknowledge the person's feelings.
- Be respectful and empowering.
- Be reasonable and identify choices.

### DO NOT:

- Be confrontational.
- Reject demands or requests.
- Use challenging body language.
- Make false statements or promises.
- Make any sudden movements.

Following any incident of violence at the College, the President will meet with any employees (or students) who have been affected to conduct a group debrief. A Trauma Counselor can (if required) be brought on site to do individual debriefing sessions.



**COQUITLAM COLLEGE**

*Established 1982*

**Emergency Response Manual**

**Appendix A: Additional Resources**

**September 2025**

**Vancouver Campus: 300-2920 Virtual Way, Vancouver, BC.**

**Table of Contents**

First Aid Attendants.....3  
Critical Contacts Directory.....4  
Emergency Evacuation Map- 3<sup>rd</sup> Floor .....5  
Emergency Evacuation Map- 4<sup>th</sup> Floor .....6  
Emergency Evacuation Map- Ground Floor.....7  
Evacuation Assembly Point .....8  
Communicable Disease Prevention Plan .....9  
Hazardous Substances Emergency Procedures .....17

### First Aid Attendants Fall 2025

Name	First Aid Training	Expiry Date	Contact Info
Penelope Cruz	Intermediate First Aid	November 29, 2027	M-F: 8:30am-4:00pm Ext. 266
Natalie Szeto	Intermediate First Aid	December 12, 2027	M-F: 8:30am-4:00pm Ext. 282
Susan Patterson	Intermediate First Aid (registered RN)	Registration #0749620	M/T/W/Th: 10:30am-2:30pm F: 9:30am-1:30pm (604) 833-6556
Alex Ferguson	Intermediate First Aid	April 21 <sup>st</sup> , 2027	M/W: Room 329: 10:10am-5:10pm
Suzy Phillips	Basic First Aid	March 10, 2026	M-F: 8:30am-4:00pm Ext. 270
Elaine Nitschke	Basic First Aid	March 10, 2026	M/W: 9:00am-5:00pm T/Th/F: 8:30am-4:30pm Ext.221
Dylan Godwin	Basic First Aid	March 10, 2026	M/W: Room 322: 10:00am-5:10pm
Sonia Chhabra	Basic First Aid	March 10, 2026	M-F: Room 344: 10:00am- 11:40am; 314: 12:20pm- 1:50pm T/Th: Room 336: 2:00pm-3:40pm
Julia Vergara	Basic First Aid	March 10, 2026	T/Th: Room 308: 10:10am-11:45am; Room 325: 12:20pm-5:25pm
Kathy Fitzpatrick	Basic First Aid	March 10, 2026	T/Th: Room 313: 8:30am-11:30am, 12:20pm-3:25pm
Ravreet Kaur	Basic First Aid	March 10, 2026	M/W: Room 330: 10:10am-11:40am; Room 359: 12:20pm- 1:50pm T/Th: Room 330: 10:10am- 11:40am; Room 359: 12:20pm-1:55pm

For concerns related to Mental Health, please contact Suzy Phillips, Mental Health Consultant.

### Critical Contacts Directory

**College Main Phone Number: 604-939-6633**

#### Internal Contacts

<b>Name</b>	<b>Title</b>	<b>Extension</b>	<b>Email</b>
Chris Rands	President	231	chrisrands@coquitlamcollege.com
Mike Williams	Chief Academic Officer	252	mwilliams@coquitlamcollege.com
Kaylene Donaldson	Chief Financial Officer	240	kaylene@coquitlamcollege.com
Jocelyn Hebeler	Registrar/Office Manager	223	jhebeler@coquitlamcollege.com
Joie Marin	Head Academic Advisor	247	joie@coquitlamcollege.com
Diana Battocchio	Director of Marketing & Business Development	227	diana@coquitlamcollege.com
Heather Corbett	Human Resources Coordinator	238	hcorbett@coquitlamcollege.com
Susan Patterson	Health & Wellness Consultant	(604) 833-6556	spatterson@coquitlamcollege.com
Brian Ralph	Facilities Manager	279	bralph@coquitlamcollege.com
BTC Security	Vancouver Campus Security	604-834-0246	N/A
Quadreal+	Building Management	877-977-2262	service@quadrealconnect.com

#### External Contacts

<b>Service</b>	<b>Phone Number</b>
Fire- Non-Emergency Line	604-665-6010
Police- Non-Emergency Line	604-717-3321
Ambulance- Non-Emergency Line	604-872-5151
Burnaby Hospital	604-434-4211
Poison Control	1-800-567-8911
Fortis BC	1-800-663-9911
BC Hydro	1-800-224-9376
BC Mental Health Society	604-524-7000
Heathlink BC	8-1-1
310 Mental Health Support	310-6789

In an emergency, call 9-1-1 immediately, then alert BTC Security.

### Emergency Evacuation Map- 3<sup>rd</sup> Floor

## IN CASE OF EMERGENCY

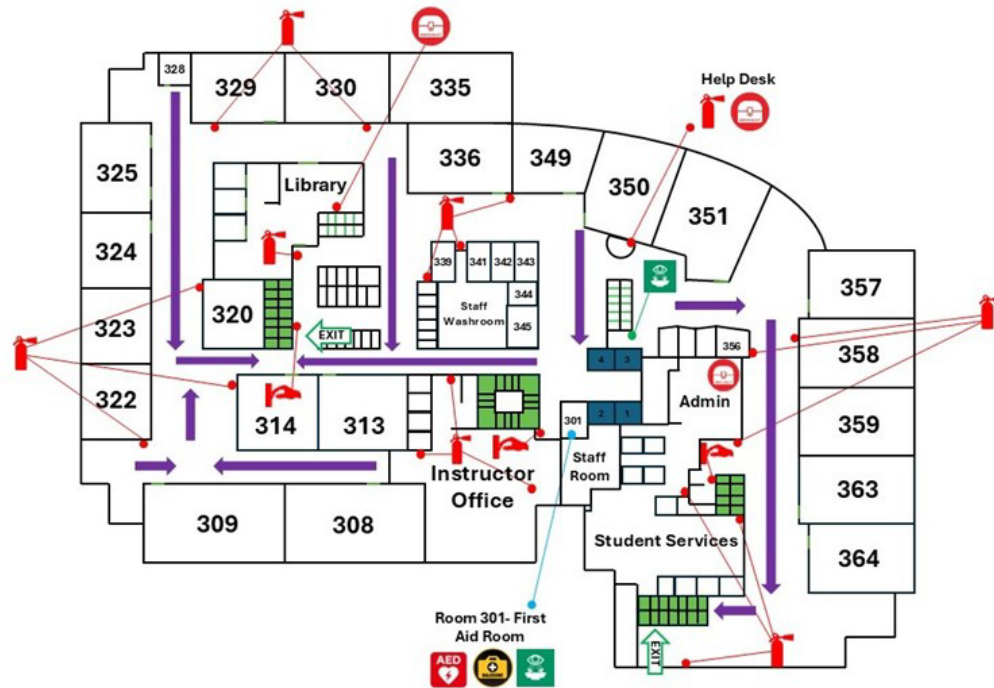

### LEGEND

-  - Fire Alarm Pull Station
-  - Fire Extinguisher
-  - Eyewash Station
-  - Exit Stairwell
-  - Elevator
-  - AED
-  - Naloxone
-  - Survival kit
-  - Emergency Exit

### IN CASE OF FIRE

- Proceed to the nearest safe fire exit
- Use stairways to exit
- Close doors behind you
- Do not use the elevators
- Activate the red alarm pull station as you leave
- Call the fire department at **911**
- Follow instructions of all Emergency Personnel
- Do not return to the building until it is safe to do so.

### OTHER EMERGENCY EVENTS

- Remain calm
- Follow instructions of all Emergency Personnel
- Do not contact security or management unless it is an emergency
- Prepare to evacuate or relocate as directed by the floor warden
- Emergency Response Plans are available in all classrooms and work areas



**BROADWAY TECH CENTRE – BUILDING 6**  
2920 Virtual Way, Vancouver, British Columbia  
3<sup>rd</sup> Floor

\*Police\*  
\*Fire\*  
\*Ambulance\*

**911**

**wps**  
www.wpsevac.com

**Emergency Evacuation Map- 4<sup>th</sup> Floor**

**IN CASE OF EMERGENCY**

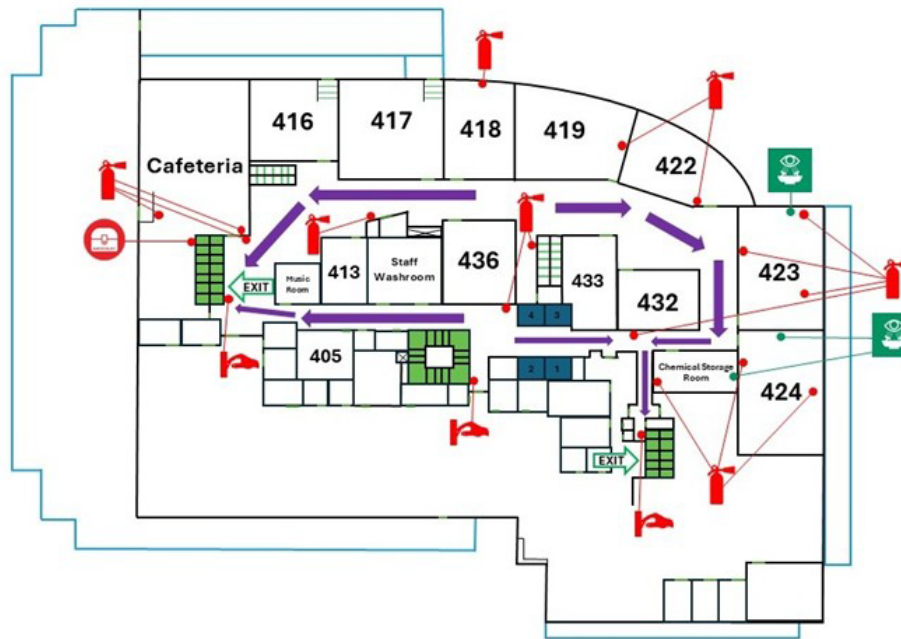

**LEGEND**

-  - Fire Alarm Pull Station
-  - Fire Extinguisher
-  - Eyewash Station
-  - Exit Stairwell
-  - Elevator
-  - AED
-  - Survival kit
-  - Emergency Exit

**IN CASE OF FIRE**

- Proceed to the nearest safe fire exit
- Use stairways to exit
- Close doors behind you
- Do not use the elevators
- Activate the red alarm pull station as you leave
- Call the fire department at **911**
- Follow instructions of all Emergency Personnel
- Do not return to the building until it is safe to do so.

**OTHER EMERGENCY EVENTS**

- Remain calm
- Follow instructions of all Emergency Personnel
- Do not contact security or management unless it is an emergency
- Prepare to evacuate or relocate as directed by the floor warden.
- Emergency Response Plans are available in all classrooms and work areas



**BROADWAY TECH CENTRE – BUILDING 6**  
2920 Virtual Way, Vancouver, British Columbia  
4<sup>th</sup> Floor

\*Police\*  
\*Fire\*  
\*Ambulance\*

**911**





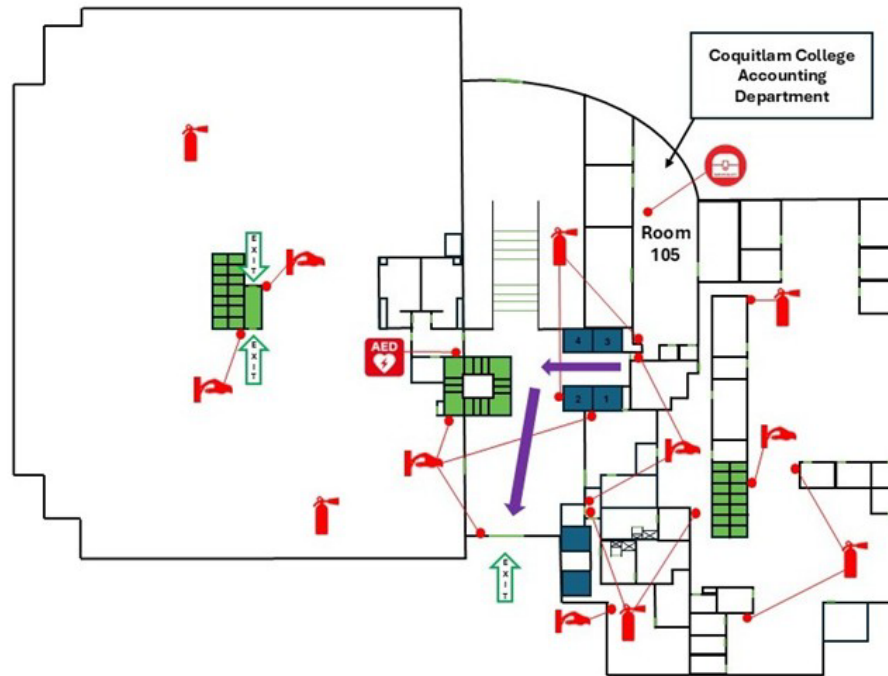

**wps**  
www.wpsevac.com

**Emergency Evacuation Map- Ground Floor**

**IN CASE OF EMERGENCY**



**LEGEND**

-  - Fire Alarm Pull Station
-  - Fire Extinguisher
-  - Survival kit
-  - Exit Stairwell
-  - Elevator
-  - AED
-  - Emergency Exit

**IN CASE OF FIRE**

- Proceed to the nearest safe fire exit
- Use stairways to exit
- Close doors behind you
- Do not use the elevators
- Activate the red alarm pull station as you leave
- Call the fire department at **911**
- Follow instructions of all Emergency Personnel
- Do not return to the building until it is safe to do so.

**OTHER EMERGENCY EVENTS**

- Remain calm
- Follow instructions of all Emergency Personnel
- Do not contact security or management unless it is an emergency
- Prepare to evacuate or relocate as directed by the floor warden.
- Emergency Response Plans are available in all classrooms and work areas



**BROADWAY TECH CENTRE – BUILDING 6**  
2920 Virtual Way, Vancouver, British Columbia  
Ground Floor

\*Police\*  
\*Fire\*  
\*Ambulance\*

**911** **wps**  
www.wpsevac.com

### Evacuation Assembly Point

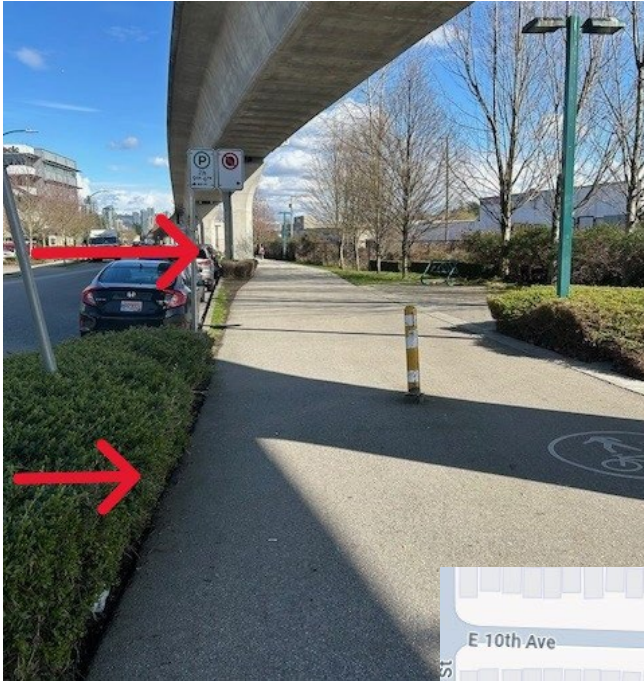

The school's Evacuation Assembly Point is across Hebb Avenue, along the sidewalk/bike path following the Skytrain tracks.

In the event of an emergency, please calmly proceed out of your nearest emergency exit, and assemble with your class/department in this area. Do not leave the evacuation area until you have spoken to your Instructor/Supervisor. If you are unaccounted for, the assumption will be made you are still inside the building, and Emergency Personnel will keep searching for you. It may also not be safe for you to leave the area.

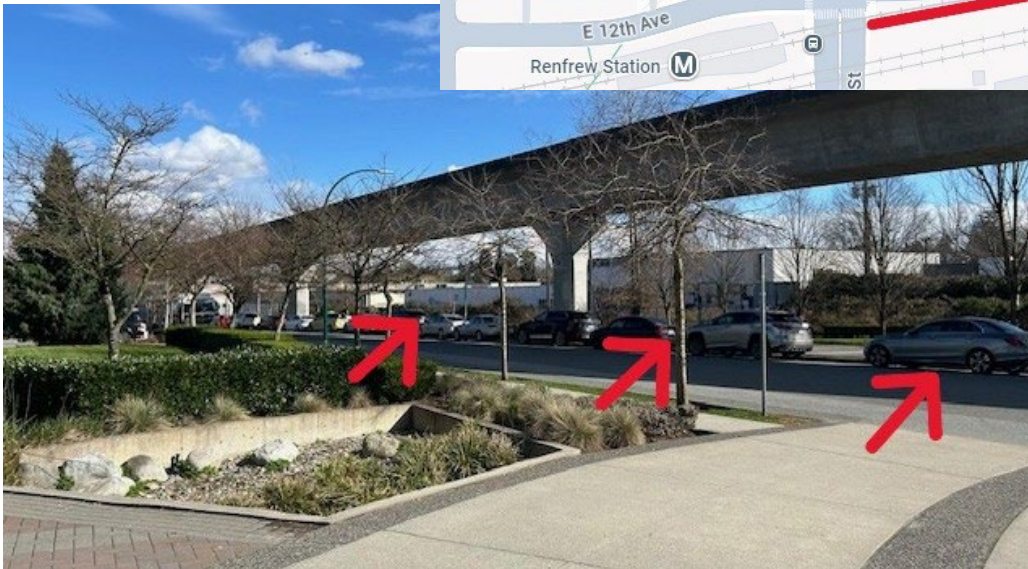
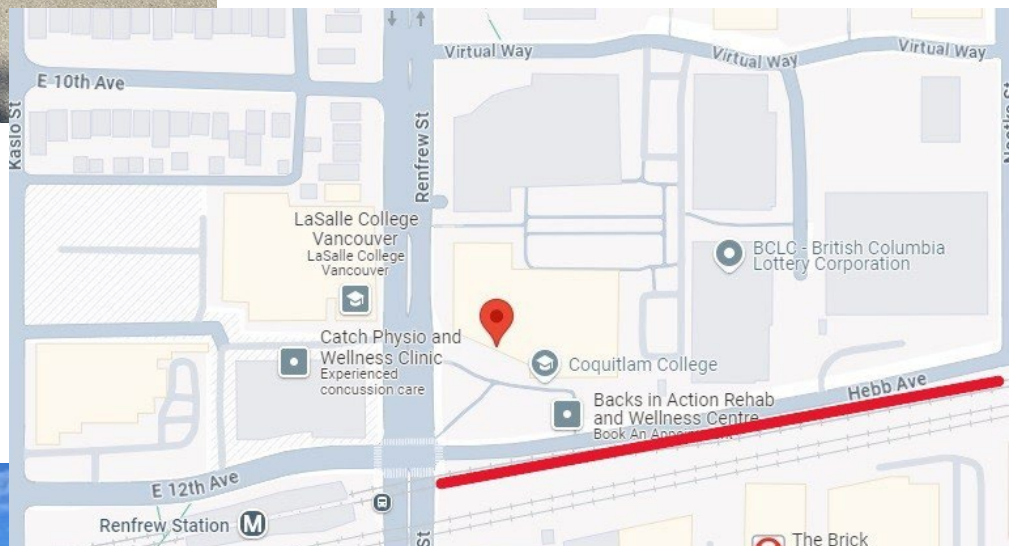

## Communicable Disease Prevention Plan

UPDATED JULY 24<sup>th</sup>, 2025

The Coquitlam College Communicable Disease Prevention Plan focuses on reducing the risk of transmission of all communicable diseases. It will be monitored and updated, based on information from [WorkSafe BC](#), [BCCDC](#), and the [Provincial Health Authority](#).

All members of the College community are to review this document and follow these operational guidelines when in any Coquitlam College campuses or properties to ensure the health and safety of themselves and others; everyone must do their part to help reduce the spread of communicable diseases.

This plan is divided according to the following:

1. Communicable Disease Prevention Guidance.
2. Communicable Disease Prevention Plans.
3. Environmental Practices.
4. Administrative Practices.
5. Personal Practices.
6. Administrator Protocols for Managing Communicable Disease Activity at the College.
7. Protocols for confirmed exposure to Communicable Disease.
8. Resources for Parents, Students and Employees.
9. Recovery.

### COMMUNICABLE DISEASE PREVENTION GUIDANCE

#### Supportive Learning Environment

The College commits to being a supportive environment for communicable disease prevention by:

- Having employees' model personal practices (i.e., [hand hygiene](#), [respiratory etiquette](#)).
- Sharing reliable information, including from the [BC Centre for Disease Control \(BCCDC\)](#), [Office of the Provincial Health Officer](#), and [local health authorities](#).
- Promoting personal best practices in the College (i.e., posters).
- Ensuring individual choices for personal practices (i.e., choosing to wear a mask or face covering) are supported and treated with respect, recognizing varying personal comfort levels.

#### Vaccines

Vaccines are important tools that protect against many serious communicable diseases and reduce the risk of transmission in the College community.

- Proof of vaccination is NOT required for at the College for employees, students, or visitors. However, students and employees are highly encouraged to ensure they are up to date on all [recommended vaccines for communicable diseases](#), including COVID-19.
- The College will share evidence-based information and promote opportunities to be vaccinated in partnership with public health and local Medical Health Officers. Evidence-based immunization information and tools for B.C. residents are available

from [BCCDC](#) and [ImmunizeBC](#) websites.

### WorkSafe BC – Communicable Disease Prevention

The College follows [WorkSafe BC communicable disease prevention guidance](#) and will provide communication, training, and orientation to ensure the health and safety of employees. WorkSafe BC communicable disease prevention guidance is aligned with the guidance provided by [BCCDC](#). Please see their website for specific requirements and additional information.

## COMMUNICABLE DISEASE PREVENTION PLANS

### Emergency and Evacuation Drills

Emergency and evacuation planning, and drills will consider the Coquitlam College Communicable Disease Prevention Plan. In the event of an actual emergency, communicable disease prevention measures can be suspended to ensure a timely, efficient, and safe response to an emergency.

## ENVIRONMENTAL PRACTICES

### Cleaning and Disinfecting

Regular cleaning and disinfection can help prevent the spread of communicable diseases. Cleaning of frequently touched surfaces must occur in line with regular practices and when visibly dirty.

#### *Products & Procedures for Cleaning and Disinfecting*

- For **cleaning**, use water and detergent (i.e., liquid dishwashing soap), or common, commercially available products, along with good cleaning practices. For hard-to-reach areas, use a brush and rinse thoroughly prior to disinfecting.
- For **disinfection**, use common, commercially available disinfectants listed on [Health Canada's hard surface disinfectants](#).
- Follow these procedures when cleaning and disinfecting:
  - Always wash hands before and after handling shared objects.
  - Items and surfaces that a person has placed in their mouths or that have been in contact with bodily fluids must be cleaned as soon as possible and between uses by different people.
  - A dishwasher can be used to clean and sanitize dishwasher-safe items if the sanitize setting is used with adequately hot water.

#### *General Cleaning and Frequently Touches Surfaces*

- Cleaning and disinfection of **frequently touched surfaces** must occur at least **once in a 24-hour period and when visibly dirty**.
- Frequently touched surfaces are items touched by larger numbers of students and/or employees. They can include doorknobs, light switches, hand railings, water fountains and toilet handles, as well as shared equipment (i.e., library circulation desk), and may change from day to day based on utilization.
- Public garbage cans that are used frequently must be emptied daily.

#### *Cleaning and Disinfecting Bodily Fluids*

Employees are to follow these procedures, in conjunction with Coquitlam College policies, when

cleaning and disinfecting bodily fluids (i.e., runny nose, vomit, stool, urine):

- Wear disposable gloves when cleaning blood or body fluids.
- Wash hands before wearing and removing gloves.
- Follow regular health and safety procedures and use PPE (i.e., gloves for blood and bodily fluids).

#### General Ventilation and Air Circulation

The Senior Leadership team will ensure all mechanical heating, ventilation, and air conditioning (HVAC) systems are operated, and maintained as per standards and specifications for ongoing comfort of workers and that they are working properly. Open windows when the weather permits if it does not impact the functioning of ventilation system.

- When using air conditioners and fans in ventilated spaces, air must be moved from high places to lower places instead of blowing air directly from one person's breathing zone to another's. Avoid horizontal cross breezes.
- Natural ventilation (operable windows, etc.) and portable HEPA filter units are acceptable in regularly occupied classrooms that do not have mechanical ventilation systems.

If the College's ventilation system is temporarily compromised, senior administration will inform employees and students of the course of action.

#### Hand Hygiene

Rigorous hand washing with plain soap and water or using an effective hand sanitizer reduces the spread of illness.

- Everyone must practice diligent hand hygiene.
- Employees are to facilitate regular opportunities for students to wash their hands.
- If hands are visibly dirty, soap and water are preferred to alcohol-based hand sanitizer.
- Employees and students can refer to [BCCDC](#) to learn about how to perform hand hygiene.
- Custodians must ensure hand hygiene supplies are always well stocked including soap, paper towels (or air dryer) and where appropriate, alcohol-based hand rub with a minimum of 60% alcohol.

#### Respiratory Etiquette

Employees will teach and reinforce good respiratory etiquette practices among students, including:

- [Cough or sneeze into their elbow or tissue. Throw away used tissues and immediately perform hand hygiene.](#)
- Refrain from touching eyes, nose, mouth with unwashed hands.
- Refrain from sharing any food, drinks, unwashed utensils, cigarettes, or vaping devices.

### ADMINISTRATIVE PRACTICES

#### Health Awareness

No member of the College community may come on-site at any college campuses or properties if they are sick and unable to participate fully in routine activities. The importance of everyone doing a health check remains in place. A health check means a person regularly checking they are not experiencing symptoms of illness that would limit their ability to participate fully in regular activities before coming to the College. A daily health check helps prevent the spread of communicable diseases within the

College.

Senior Leaders must ensure that everyone entering the College is aware and routinely reminded of their responsibility to practice health awareness, including staying home if they are sick.

### What To Do When Sick

Any member of the College community who are exhibiting any symptoms of illness must stay home until they are well enough to participate in regular activities, unless their symptoms are consistent with a previously diagnosed health condition (i.e., seasonal allergies). They may return once their symptoms have improved enough to return to regular activities and any fever has resolved without the use of fever-reducing medication. If someone is unsure or concerned about their symptoms, they are encouraged to contact their health care provider or call 8-1-1.

If an employee or student develops symptoms of illness at the College, and is unable to participate in regular activities, they will be supported to go home until their symptoms have improved.

Appropriate infection control precautions are to be taken while the person is preparing to leave the College campus, including:

- Using appropriate hand hygiene and cleaning.
- Disinfecting surfaces soiled with bodily fluids.
- Using a mask if they are experiencing respiratory symptoms.
- Making arrangements for the student/employee to go home as soon as possible.
- Having a space available where the ill student or employee can wait comfortably for someone to pick them up that is separated from others.
- Cleaning and disinfecting surfaces/equipment which the ill person's bodily fluids may have been in contact with prior to the surfaces/equipment being used by others.
- Requesting that the individual employees stay home until symptoms have improved and they feel well enough to participate in all college-related activities.

### Supporting Employees and Students with Disabilities/Diverse Abilities and/or Receiving Health Services

Coquitlam College is committed to providing health and safety measures that promote the inclusion of students and employees with disabilities/diverse needs. If any accommodation is required, please email the Human Resources Coordinator for employees, or review [2.2.4. Accessible Learning](#) for students.

### Space Arrangement

The College can use classroom and learning environment configurations and activities that best meet learner needs and preferred educational approaches. This may be altered in the event of a communicable disease outbreak.

### Transportation – Buses

When using the Coquitlam College bus:

- Following the transport of students, the bus must be cleaned and disinfected following in line with the cleaning and disinfection practices outlined in this document.
- Drivers and students must practice hand hygiene and respiratory etiquette.
- Drivers, instructors, and students may choose to wear masks or face coverings when they are on the bus.

### Visitor Access

The College may follow normal practices for welcoming visitors to its campuses.

- All visitors must follow the Coquitlam College Communicable Disease Prevention Plan.

#### Curriculum, Programs & Activities

The College will implement communicable disease prevention practices (i.e., cleaning and disinfecting, hand hygiene, respiratory etiquette) specific to the activity.

#### Field Trips

When planning field trips, employees must follow existing policies and procedures as well as the guidance in this document.

#### Physical & Health Education/Other Shared Equipment Programs

Students must be encouraged to practice proper hand hygiene before and after shared equipment use. Equipment that touches the mouth or has been in contact with bodily fluids must not be shared unless cleaned and disinfected between uses.

#### College Library/Learning Commons

Regular book browsing and circulation processes can occur as per routine practice.

### PERSONAL PRACTICES

#### Health Awareness

All members of the College community must practice health awareness, including staying at home when sick. See 'Administrative Practices' (Section 4 in this document).

#### Non-Medical Masks and Face Coverings

The decision to wear a mask beyond when it is required by public health is a personal one, based on individual preference. Students and employees may choose to continue to wear a non-medical mask or face covering throughout the day or for certain activities. The choice of employees and students to choose whether they practice additional personal prevention measures is to be respected.

- Information on non-medical masks is available from [BCCDC](#).
- Masks are most effective when fitted, worn, and handled correctly.
- Senior Leaders must set, communicate, and consistently reinforce clear expectations that any bullying or other disrespectful behavior or conduct related to personal mask choice is unacceptable.
- Senior Leaders must address inappropriate behavior in line with either the Student or Employee's Code of Conduct.

#### Hand Hygiene & Respiratory Etiquette

See 'Environmental Practices' (Section 3 in this document).

Employees, students, and visitors will be encouraged to practice frequent hand hygiene. To learn about how to perform hand hygiene, please refer to the [BCCDC's hand hygiene poster](#).

Employees and students are encouraged to respect others' personal space.

#### Sharing Food, Beverages, & Other Items That Touch the Mouth

Employees and students are encouraged not to share items that come in contact with the mouth. Shared-use items that touch the mouth must be cleaned and disinfected between use by different individuals.

### International Travel Requirements Following Return to Canada

Employees, students, and families are responsible for understanding and adhering to all international travel requirements outlined by the Government of Canada, including those required following return to Canada. At the time of this policy's update, there are no active vaccination requirements for entrance into Canada. It's advised to check the [Government of Canada's website](#) anytime you are travelling though, to ensure you have the most current information.

### ADMINISTRATOR PROTOCOLS FOR MANAGING COMMUNICABLE DISEASE ACTIVITY AT THE COLLEGE

The President or Designate and Senior Leadership team will monitor and review current information related to communicable diseases as the provincial health authority distributes it. They will update this plan according to the most current information available.

Risk Assessments will be conducted annually by the President or Designate and the Joint Health and Safety Committee (JHSC) to assess the hazards present at the College, including the risk of a communicable disease outbreak.

Public health may become directly involved if certain reportable diseases, such as tuberculosis, are identified where there are effective interventions available to prevent further spread and protect against severe disease. Additional time-limited public health measures may also be implemented at the discretion of the local Medical Health Officer or the Provincial Health Officer in response to broader risk of communicable disease transmission in the community. The President or Designate may choose to contact public health if they have concerns about communicable disease transmission within the College and require additional support.

### Communications and Protecting Personal Privacy

Medical Health Officers and Provincial Health Authorities play the lead role in determining, if, when and how to communicate information regarding increased communicable disease activity within the College. To protect personal privacy and to support accuracy, the College will exercise caution in providing communicable disease notifications beyond when and what is recommended by Public Health Authorities. Appropriate signage will be posted regarding any when/if there are changes in practices or policies regarding preventative health measures at the College.

### Public Health Closure

A public health closure is the temporary closing of a company or institution ordered by a Medical Health Officer when they determine it is necessary to prevent the excessive transmission of a communicable disease.

### Reporting a healthy and/or safety concern

Any member of the College community has the right to report a concern regarding health and/or safety, including concerns regarding the transmission of communicable diseases. They may report their concern directly to the President or Designate via email, or to any member of the JHSC. If the concern has no immediate solution, then it will be brought forward to the JHSC for discussion, and to find a resolution.

### PROTOCOLS FOR CONFIRMED EXPOSURE TO COMMUNICABLE DISEASE

#### Confirmed Case of Communicable Disease

In the event that there is a confirmed case of Communicable Disease at the College, all measures recommended or required by the Public Health Authorities will guide the College's response.

If a student or employee reports having a confirmed case of Communicable Disease, they will be directed to the College's Health & Wellness Consultant for further information on reporting requirements.

If the College is contacted by a Public Health Officer to confirm that a student or employee has a confirmed case of Communicable Disease, it will provide a list of all potentially exposed students & staff to the relevant Public Health Authorities, in line with the [Reporting Information Affecting Public Health Regulation](#). The Public Health Authorities will contact individuals directly to provide directions regarding testing and/or other requirements.

If a person who has been exposed to a Communicable Disease begins developing symptoms of the illness, they should contact the Public Health Authorities immediately and follow all instructions. If an employee or student is required to quarantine, they must contact either Student Services, or their direct Supervisor.

## RECOVERY

### Trauma-Informed Practice

The College recognizes that stress and anxiety caused by the spread of communicable diseases (or the fear of them being spread) can lead to trauma among the College community. [Trauma-informed practices](#) will be used to create a supportive learning environment for those who are experiencing trauma related to health & safety concerns.

As part of trauma-informed practices in the college, employees are:

- Make college spaces a safe, inclusive, and empathetic environment.
- Understand everyone will have different coping strategies when facing stress or anxiety.
- Support a person's right to choose the strategies, support, and course of action they feel is best for their personal situation.
- Help to minimize additional stress or trauma by addressing the individual needs of students and colleagues (or referring to higher level counseling services, EFAP program, etc).

## RESOURCES FOR PARENTS, STUDENTS AND EMPLOYEES

- Call 310Mental Health Support at [310-6789](tel:310-6789) for mental health information, resources, and emotional support.
- Youth and adults 15+ can [sign up for the BounceBack program](#) to learn to manage mental health and well-being.
- Resources are available to support management of routine communicable diseases, including [HealthLinkBC](#), the [BCCDC Guide to Common Childhood Diseases](#), and other health resources hosted on [Fraser Health](#) website.
- [Resources for parents/caregivers of children with disabilities and diverse abilities](#)
- [Provincial Outreach Programs](#) are available to support educational authorities through professional learning, resources, consultation, and training during recovery.
- [Indigenous Education in British Columbia](#)
- [Communicable disease prevention \(G-P2-21\)](#)
- [MCFD: Healing Families, Helping Systems: A Trauma-Informed Practice Guide for Working with Children, Youth and Families](#)

- [Office of the Provincial Health Officer](#)

## DEFINITIONS

College campuses and properties: Any building, structure, parking lots, space or land controlled, owned, leased, and/or occupied by the College.

College community: Employees, students, representatives, and any other person involved with or in attendance at the College.

Communicable Disease: An illness caused by an infectious agent or its toxic product that can be transmitted from one person to another.

Joint Health and Safety Committee (JHSC): An advisory group consisting of employers and employees working to improve occupational health and safety in their workplace.

Occupational Hazard: A hazard experienced in the workplace. This encompasses chemical hazards, biological hazards, psychosocial hazards, and physical hazards.

Occupational Health and Safety Program: A defined plan of action designed to prevent incidents and occupational diseases. This plan must be communicated clearly to all employees.

Risk Assessment: A term used to describe the overall process or method where you:

- Identify hazards and risk factors that have the potential to cause harm (hazard identification).
- Analyze and evaluate the risk associated with that hazard (risk analysis, and risk evaluation).
- Determine appropriate ways to eliminate the hazard or control the risk when the hazard cannot be eliminated (risk control).

Trauma Informed Practices: A strengths-based framework grounded in an understanding of and responsiveness to the impact of trauma. It emphasizes physical, psychological, and emotional safety for everyone, and creates opportunities for survivors to rebuild a sense of control and empowerment.

## RELATED DOCUMENTS

[1.4.4 Occupational Health and Safety](#)

[2.2.2. Student Non-Academic Conduct](#)

[3.1.2. Employee Professional Standards and  
Conflict of Interest](#)

[Communicable disease prevention: A guide for employers  
Government of Canada- COVID-19 proof of vaccination in  
Canada](#)

[BC Centre for Disease Control](#)

[Trauma Informed Care Implementation Resource Center](#)

[Provincial Health Services Authority](#)

[Office of the Provincial Health Officer](#)

## Hazardous Substances Emergency Procedures

**UPDATED MARCH 26<sup>th</sup>, 2025**

Coquitlam College is committed to ensuring the safety and health of all employees, students, and visitors by maintaining a safe and healthy environment when working with or around hazardous substances. These guidelines outline our compliance with WorkSafeBC's requirements for the handling of Hazardous Substances, and with the Workplace Hazardous Materials Information System (WHMIS).

### ROLES AND RESPONSIBILITIES

The Senior Leadership Team is responsible for:

- a) Allocating necessary resources for the implementation of a hazardous substances program.
- b) Ensuring compliance with WorkSafeBC & WHMIS regulations.
- c) Reviewing and updating the Hazardous Substances Emergency Procedures as needed.

The Facilities Manager is responsible for:

- a) Ensuring all potentially hazardous substances are properly labeled and documented.
- b) Conducting inventories (in conjunction with the Joint Health & Safety Committee) of all potentially hazardous substances in the workplace.

Human Resources is responsible for:

- a) Developing, implementing, and monitoring the hazardous substances program, and updating as necessary.
- b) Monitoring and tracking completion of WHMIS training for any staff who may come into regular contact with hazardous substances.

Employees and Students are responsible for:

- a) Attending any required hazardous substances training.
- b) Following safe practices when handling, using, storing, or disposing of hazardous substances.
- c) Reporting unsafe conditions or incidents involving hazardous substances to the Facilities Manager.

### PROCEDURES

1. Employees and students working with or near hazardous substances will receive appropriate safety training.
2. All incidents involving hazardous substances must be promptly reported to the Facilities Manager. An investigation will be conducted, and corrective actions will be taken as necessary.
3. The Hazardous Substances Emergency Procedures will be reviewed annually and updated as needed to reflect changes in regulations, best practices, or the needs of Coquitlam College.

### HAZARDOUS SUBSTANCE HANDLING AND STORAGE

4. The College will:

- a) Maintain an up-to-date inventory of all hazardous substances used or stored on campus.
- b) Ensure all containers of hazardous substances are properly labeled with the product name, hazard symbols, and appropriate warnings.
- c) Maintain up to date Safety Data Sheets (SDS) for any hazardous substances that will be used, handled, or stored at the College.
- d) Store hazardous substances in designated areas with appropriate ventilation and storage conditions.
- e) Provide and require the use of appropriate PPE when handling hazardous substances.
- f) Develop and communicate clear procedures for responding to hazardous substances spills, leaks, and accidents.

## DISPOSAL OF HAZARDOUS SUBSTANCES

5. The College will ensure all Hazardous Substances are safely disposed of by:
  - a) Carefully segregating the substance(s) based on their hazard class after consulting the SDS.
  - b) Wastes that do not exhibit any of the hazardous characteristics (ignitability, corrosivity, reactivity, toxicity) are designated as non-hazardous chemical wastes, which are disposed of via normal garbage (solids) or sewer disposal (liquids). Dilute aqueous solutions of these materials are generally acceptable for sewer disposal (washed down drains with excess water).
  - c) Acid-base neutralization is another method for safely disposing of acidic and basic chemical waste. Once neutralized, these solutions can be safely disposed of down the drain with excess water.
  - d) Any hazardous chemical waste, highly concentrated stock solutions, or large quantities of chemicals are stored in designated containers and picked up from the College campus by a Hazardous Waste Disposal Company for safe disposal.

## PROCEDURES FOR MANAGING HAZARDOUS SUBSTANCES SPILLS, LEAKS, AND ACCIDENTS (RELEASE)

6. Coquitlam College is committed to responding quickly and appropriately to events of accidental or unintended release of hazardous substances which present a risk to human health, the environment, or property due to their toxic, flammable, reactive, or corrosive nature.
7. Spill kits containing detailed instructions, absorbent materials, reactive agents, and protective gear are readily accessible to address minor hazardous substances spills.

## MINOR RELEASE

8. If a spill, leak, or accident occurs that is less than or equal to 4 litres of hazardous substance and does not present an immediate health risk or result in contamination to the body, it is considered as a minor release.
9. For minor releases:
  - a) Evacuate the area immediately if you are not trained to handle the hazardous substance or if it poses an immediate danger to health or safety.

- b) Only trained personnel should perform the cleanup by using appropriate substance response materials and equipment. If safe to do so, put on appropriate personal protective equipment (PPE), including gloves, goggles, and lab coats.
- c) Remove ignition sources and unplug nearby electrical equipment. Clearly mark the area to warn others of the spill.
- d) Follow the SDS guidelines for the specific substance involved and confine the release by using appropriate absorbent materials (e.g., spill kits) to prevent further spread.
- e) Collect all contaminated materials and place them in appropriate disposal container. Do not dispose of hazardous substances in regular trash.
- f) Document the release, response actions taken, and any injuries or exposure and report the incident to the Facilities Manager, Human Resources, and Health & Wellness Consultant (if First Aid was required).

## MAJOR RELEASE

10. For major releases involving hazardous substances leading to uncontrolled fires, or explosions and presenting an imminent threat to health and safety:
  - a) Promptly inform individuals in proximity of the incident.
  - b) Evacuate the area immediately by activating the nearest fire alarm pull station. Follow evacuation routes to the assembly point as per the College's Emergency Response Plan.
  - c) Secure area by restricting access and posting signs if it is safe to do so.
  - d) Dial 911 to report the emergency, specifying its nature, and request immediate assistance.
  - e) Provide comprehensive accident details, including the incident's location, the nature of hazardous materials involved, and any incidents of personal injury.
  - f) Call BTC Security (Vancouver Campus) at (604) 834-0246 and provide them with as much information as possible:
    - Your name and contact information.
    - The location of the release (building, room number, or specific area).
    - The type of substances involved (if known).
    - The approximate quantity of the substance.
    - Any injuries or medical issues resulting from the substance.
    - Any safety measures you've already taken.
  - g) Before attempting any response actions, prioritize your safety and the safety of others. If you encounter hazardous substances, follow these general safety guidelines:
    - If you or someone else is injured or experiencing symptoms, seek medical attention immediately.
    - If the release involves corrosive substances or irritants, rinse affected areas with water for at least 15 minutes.
    - Remove contaminated clothing if safe to do so.
    - If there's a potential for inhalation exposure, move to an area with fresh air.
  - h) Submit a written report to the President stating the names of all persons involved in the incident and details of any personal contamination.

## FOLLOWING ANY RELEASE OF HAZARDOUS SUBSTANCES IN THE WORKPLACE

### 11. In the event of:

- a) Death or severe injury of an employee.
- b) Major release of a hazardous substance.
- c) Fire and/or explosion.
- d) Blasting accident that causes injury.
- e) Incident involving explosives.
- f) Major structural failure.

WorkSafe BC must be notified immediately. The President or Designate, or most senior staff member present must call WorkSafe BC's prevention emergency line (604-276-3301) to report the incident as soon as possible.

12. Any hazardous substance release in the workplace should be recorded using Coquitlam College's [Incident Reporting Form](#) as soon as possible.
13. If an employee has lost any work time due to an injury sustained in the workplace, they should contact the Chief Financial Officer immediately.

## DEFINITIONS

Corrosive substances: A chemical that can cause irreversible damage to living tissue upon contact, often leading to burns or tissue destruction.

Hazard Symbols: Graphic images that immediately show the user of a hazardous product what type of hazard is present. Training on hazard symbols are part of the WHMIS program.

Hazardous Substance: Any material (liquid, gas, or solid) at a workplace that can cause an emergency, or aggravate the effects of an emergency, including risk to a person.

Irritants: A substance that causes a reversible inflammatory reaction on skin or mucous membranes, like redness or itching, but does not cause deep tissue damage.

Joint Health & Safety Committee: An advisory group made up of management and employees working together to improve occupational health and safety in the workplace.

Personal Protective Equipment (PPE): Clothing and/or equipment that is worn or used in order to provide protection against hazardous substances or environments.

Reactive agents: For the purposes of these procedures, a substance in a spill kit that will neutralize a specific kind of hazardous substance (i.e. acids, bases, chlorine, etc.).

Safety Data Sheets (SDS): Summary documents that provide information about the hazards of a product and advice about safety precautions.

Workplace Hazardous Materials Information System (WHMIS): A comprehensive system for providing health and safety information on hazardous products intended for use, handling, or storage in workplaces.

**Related Documents**

[1.4.3 Emergency Management](#)

[1.4.4 Occupational Health and Safety](#)

[Incident Reporting Form](#)

[WorkSafeBC](#)

[Canadian Centre for Occupational Health and Safety](#)



**COQUITLAM COLLEGE**

*Established 1982*

**Emergency Response Manual**

**Appendix B: Coquitlam College Forms**

**September 2025**

**Vancouver Campus: 300-2920 Virtual Way, Vancouver, BC.**

## Contents

Bomb Threat Form .....	3
Incident Report .....	4
Situation Report .....	5

### Bomb Threat Form

Instructions: Remain calm and be courteous with the caller. Do not interrupt the caller. Pretend you can't hear the caller and try to keep the caller talking. Fill out the form below with as much information as possible.

1. Where is the bomb going to explode?	5. What will cause the bomb to explode?
2. When is the bomb going to explode?	6. Did you place the bomb? If so, why?
3. What does the bomb look like?	7. What is your address?
4. What kind of bomb is it?	8. What is your name?
Exact wording of the threat:	

Time of Call:	Date:	Phone Number Call Received From:
Accent: <input type="checkbox"/> Slavic <input type="checkbox"/> Local <input type="checkbox"/> Southern <input type="checkbox"/> Middle East <input type="checkbox"/> Northern <input type="checkbox"/> Hispanic <input type="checkbox"/> Midwestern <input type="checkbox"/> African <input type="checkbox"/> Other: _____	Manner: <input type="checkbox"/> Angry <input type="checkbox"/> Calm <input type="checkbox"/> Irrational <input type="checkbox"/> Rational <input type="checkbox"/> Incoherent <input type="checkbox"/> Coherent <input type="checkbox"/> Emotional <input type="checkbox"/> Deliberate <input type="checkbox"/> Laughing <input type="checkbox"/> Righteous <input type="checkbox"/> Other: _____	Background: <input type="checkbox"/> Trains <input type="checkbox"/> Machines <input type="checkbox"/> Animals <input type="checkbox"/> Music <input type="checkbox"/> Voices <input type="checkbox"/> Office <input type="checkbox"/> Airplanes <input type="checkbox"/> None <input type="checkbox"/> Other: _____ <input type="checkbox"/> Traffic _____
Voice: <input type="checkbox"/> Soft <input type="checkbox"/> Loud <input type="checkbox"/> Deep <input type="checkbox"/> High Pitch <input type="checkbox"/> Pleasant <input type="checkbox"/> Raspy <input type="checkbox"/> Other: _____ <input type="checkbox"/> Intoxicated _____	Speech: <input type="checkbox"/> Slow <input type="checkbox"/> Fast <input type="checkbox"/> Stutter <input type="checkbox"/> Distinct <input type="checkbox"/> Nasal <input type="checkbox"/> Distorted <input type="checkbox"/> Other: _____ <input type="checkbox"/> Slurred _____	Language: <input type="checkbox"/> Excellent <input type="checkbox"/> Fair <input type="checkbox"/> Good <input type="checkbox"/> Poor <input type="checkbox"/> Other: _____ <input type="checkbox"/> Foul _____ <input type="checkbox"/> Other: _____
Gender: <input type="checkbox"/> Male <input type="checkbox"/> Female	<input type="checkbox"/> Adult <input type="checkbox"/> Juvenile	Call Origin: <input type="checkbox"/> Local <input type="checkbox"/> Non-Local
Your Name:	Your Phone Number:	
Your Position:	Date of Report:	

### Incident Report

Date of Incident: \_\_\_\_\_ Time of Incident: \_\_\_\_\_ Employee Name/Student ID: \_\_\_\_\_

Original Report:  Incident Update:  Update #: \_\_\_\_\_

**Incident Type:**

Medical Emergency:  Fire:  Workplace Violence:  Explosion:

Bomb Threat:  Natural Disaster:  Chemical Accident:  Severe Weather:

Location/Site of Event:
Initial Situation/Summary of Incident:
Anticipated Action/Action Undertaken:
Agencies Involved in Response:

**Severity of Incident:** Major:  Moderate:  Mild:  Unknown:

Injuries Sustained:
---------------------

**Post-Incident**

Outcome of the Incident (property damage, hospitalization of staff, etc.):
Contributing Factors to the Incident:
Corrective Measures Undertaken:

In the event of death/severe injury, major release of hazardous substance, fire/explosion, blasting accident causing injury, incident involving explosives, or major structural failure, WorkSafe BC must be notified immediately. The President or Designate, or most senior staff member present must call (604) 276-3301 and report the incident as soon as possible.

WorkSafe BC notified (if necessary):  Joint Health & Safety Committee notified (if necessary):

Employee Signature: \_\_\_\_\_ Date: \_\_\_\_\_

President or Designate Signature: \_\_\_\_\_ Date: \_\_\_\_\_

**Situation Report**

Date of Report: \_\_\_\_\_ Time of Report: \_\_\_\_\_

**Primary Contact:**

Name:	Job Title:
Phone Number:	Email:

**Incident Information:**

Summary of event:

**Severity of Incident:** Major:  Moderate:  Mild:  Unknown:

**Overall status:** Major assistance required:  Assistance required:  Under Control:

Resolved:  Unknown:  Closed:

**Overall status:** Worsening:  Stable:  Improving:  Unknown:

Summary of updates since last report (if applicable):
Current objectives/priorities:
Future objectives/priorities:
Concerns:

**Site-Support Activities:**

Campus Closure:  Effective Date: \_\_\_\_\_ Anticipated Cancellation Date: \_\_\_\_\_

Shelter-in-Place:  Effective Date: \_\_\_\_\_ Coverage Area: \_\_\_\_\_

Evacuation Order:  Effective Date: \_\_\_\_\_ Coverage Area: \_\_\_\_\_

**Major Impacts to Personnel (include confirmed & unconfirmed numbers):**

Evacuated:  # of people: \_\_\_\_\_ Injured:  # of people: \_\_\_\_\_ Fatalities:  # of people: \_\_\_\_\_

Missing:  # of people: \_\_\_\_\_

**Public Information and Media Issues:**

Date of communications made: \_\_\_\_\_ Time of communications made: \_\_\_\_\_

Sources of official college communications:
Information made publicly available regarding the incident:
Media sources reporting the incident:

Other Comments:
List of attachments (if applicable:

Employee Signature: \_\_\_\_\_

Date: \_\_\_\_\_

President or Designate Signature: \_\_\_\_\_

Date: \_\_\_\_\_



**COQUITLAM COLLEGE**

*Established 1982*

**Emergency Response Manual**

**Appendix C: WorkSafeBC Forms**

**September 2025**

**Vancouver Campus: 300-2920 Virtual Way, Vancouver, BC.**

- ❖ **Worker's Report of Injury or Occupational Disease to Employer**
- ❖ **Employer's Report of Injury or Occupational Disease**
- ❖ **Employer's Statement of Return to Work**

# Worker's Report of Injury or Occupational Disease to Employer

RESET

**► Submit directly to employer. Do NOT submit to WorkSafeBC.**

Section 149(4) of the *Workers Compensation Act* requires that, where a worker is fit, and on request of the employer, they must provide the employer with particulars of the injury or occupational disease on a report prescribed by WorkSafeBC and supplied to the worker by the employer. This is the report prescribed.

- If requested by employer, please complete this report as it appears.
- This report should be completed by the injured worker if fit to do so. It can be completed by another individual for signature by the injured worker.
- If you need assistance with completing this form, please call WorkSafeBC Claims Call Centre at 604.231.8888 or toll-free throughout Canada at 1.888.967.5377, Monday to Friday, 8 a.m. to 6 p.m. PST.

## Worker's information

WorkSafeBC claim number (if known) <b>X</b>				Customer care number (if known) <b>X</b>			
Worker's last name				First name		Middle initial	
Date of birth (yyyy-mm-dd)		Personal health number (BC Services/CareCard)		Social insurance number			
Address line 1				Address line 2			
City		Province/State	Country (if not Canada)		Postal code/Zip		
Home phone number (include area code)				Business phone number (include area code)		Business extension	
Occupation						Gender <input type="checkbox"/> Male <input type="checkbox"/> Female	

## Employer's information

Employer's organization name			
Type of business (if known)		Operating location (if known)	
Address line 1		Address line 2	
City	Province/State	Country (if not Canada)	Postal code/Zip
Employer's contact name		Employer's phone number (include area code)	Extension

## Incident information

1. Date and time of incident (yyyy-mm-dd) <input type="checkbox"/> a.m. <input type="checkbox"/> p.m.	<b>OR</b>	2. Period of exposure resulting in occupational disease (yyyy-mm-dd) From _____ To _____
3. Date and time my injury or disease was first reported to my employer (yyyy-mm-dd) <input type="checkbox"/> a.m. <input type="checkbox"/> p.m.	My injury or disease was first reported to (please check one) <input type="checkbox"/> First aid <input type="checkbox"/> Supervisor <input type="checkbox"/> Office <input type="checkbox"/> Other (specify)	

# Worker's Report of Injury or Occupational Disease to Employer

Worker's last name	First name	Middle initial	WorkSafeBC claim number X
Social insurance number		Personal health number (BC Services card/CareCard)	

## Incident information (continued)

4. Name of person reported to		
5. Did you receive first aid? <input type="checkbox"/> Yes <input type="checkbox"/> No ▶	6. Date of first aid (yyyy-mm-dd)	7. Name of first aid attendant X
8. Did you go to the hospital, a medical clinic, or see a physician? <input type="checkbox"/> Yes <input type="checkbox"/> No ▶	9. If yes, name of physician or provider (if known) X	
10. Address of physician or provider (if known)		
11. Are you aware of any recent pain or disability in the area of your reported injury? <input type="checkbox"/> Yes <input type="checkbox"/> No ▶	If yes, please explain	
12. Was protective equipment being used? <input type="checkbox"/> Yes <input type="checkbox"/> No	13. Were there any witnesses? <input type="checkbox"/> Yes <input type="checkbox"/> No	
14. The supervisor in charge at the time of my injury was		
15. Describe how the incident happened		
16. Describe the injury in detail (what part of the body was injured)		
17. Side of body injured <input type="checkbox"/> Left <input type="checkbox"/> Right <input type="checkbox"/> Both <input type="checkbox"/> Not applicable		

# Worker's Report of Injury or Occupational Disease to Employer

Worker's last name	First name	Middle initial	WorkSafeBC claim number X
Social insurance number		Personal health number (BC Services card/CareCard)	

## Incident information (continued)

18. Describe the work incident location (address, city, province) and where incident occurred (e.g., shop floor, lunchroom, parking lot)

19. Contributing factors — select **at least one**, and as many as applicable

<input type="checkbox"/> Lifting _____	<input type="checkbox"/> lb	<input type="checkbox"/> kg	<input type="checkbox"/> Animal bite
<input type="checkbox"/> Overexertion	<input type="checkbox"/> Struck	<input type="checkbox"/> Assault	<input type="checkbox"/> Motor vehicle accident
<input type="checkbox"/> Repetitive (activity repeated over and over again)	<input type="checkbox"/> Crush	<input type="checkbox"/> Unsure/other (please explain below)	
<input type="checkbox"/> Slip or trip	<input type="checkbox"/> Sharp edge		
<input type="checkbox"/> Twist	<input type="checkbox"/> Fire or explosion		
<input type="checkbox"/> Fall	<input type="checkbox"/> Harmful substance in the work environment		

20. Did you or will you miss any time from work beyond the date of injury or exposure?

Yes    No

## Signature and report date

21. Worker's signature	22. Date of report (yyyy-mm-dd)
------------------------	---------------------------------

## Additional information

The BC Legislature provides impartial advisers on all workers' compensation matters. The Workers' Advisers Office (WAO) provides free advice and assistance to workers and their dependants on disagreements they may have with WorkSafeBC decisions. WAO operates independently of WorkSafeBC.

Phone: 604.335.5931

Toll-free: 1.800.663.4261

Website: [gov.bc.ca/workersadvisers](http://gov.bc.ca/workersadvisers)

WorkSafeBC collects information on this form for the purposes of administering and enforcing the *Workers Compensation Act*. That Act, along with the *Freedom of Information and Protection of Privacy Act*, constitutes the authority to collect such information. To learn more about the collection of personal information, contact WorkSafeBC's freedom of information coordinator at PO Box 2310 Stn Terminal, Vancouver BC, V6B 3W5, or call 604.279.8171.



As an employer, the *Workers Compensation Act* requires you to submit this report **within three days** of an injury to one of your workers, even if you disagree with the claim. By submitting your report promptly, you avoid penalties and delays in the adjudication of the claim. Please report using one of the following options:

- Online — The quickest and easiest option:** The online screen application customizes questions to the worker's injury. You can save your report and update it later with new information. Once submitted, you can follow the status of the claim online. Go to [worksafebc.com](http://worksafebc.com) and select "Report injury or illness."
- Fillable PDF form:** Type in your details online, print the form, and submit it by **fax** or **mail**. Go to [worksafebc.com](http://worksafebc.com) and select "Report injury or illness."
- Paper form:** Clearly **print** details, sign the form, and submit it by **fax** or **mail**.

**Fax: 604.233.9777** in Greater Vancouver or **toll-free** within BC at **1.888.922.8807**  
**Mail:** WorkSafeBC, PO Box 4700 Stn Terminal, Vancouver BC V6B 1J1

RESET

<b>Employer information</b>					WorkSafeBC claim number (if known)																
Employer's name (as registered with WorkSafeBC)				Type of business				WorkSafeBC account number			Classification unit number			Operating location number							
Employer address line 1 (mailing)				Employer contact last name				First name			Employer address line 2 (mailing)			Employer contact telephone (and area code)			Extension		Employer contact fax (and area code)		
City				Province/state				Employer payroll contact last name			First name			Country (if not Canada)			Postal code/zip				
Employer payroll contact telephone (and area code)				Extension			Employer payroll contact fax (and area code)														

**Worker information**

Worker last name				First name				Middle initial							
Date of birth (yyyy-mm-dd)				Home phone number (include area code)				Social insurance number							
Address line 1						Address line 2									
City				Province/state				Country (if not Canada)				Postal code/zip			

1. What is the worker's occupation?				2. Has the worker been employed by this firm for less than 12 months? <input type="checkbox"/> Yes <input type="checkbox"/> No				3. If yes, start date (yyyy-mm-dd)							
4. At the time of injury, was the worker (check all that apply)															
<input type="checkbox"/> Permanent		<input type="checkbox"/> Apprentice		<input type="checkbox"/> Self-employed		<input type="checkbox"/> Casual		<input type="checkbox"/> Temporary		<input type="checkbox"/> Volunteer		<input type="checkbox"/> Principal/partner or relative of employer		<input type="checkbox"/> Other (specify)	
<input type="checkbox"/> Full time		<input type="checkbox"/> Student		<input type="checkbox"/> Fisher		<input type="checkbox"/> Hired on a contract basis		<input type="checkbox"/> Part time		<input type="checkbox"/> New entrant to workforce					

**Incident information**

5. Date of incident (yyyy-mm-dd)				Time of incident (hh:mm) <input type="checkbox"/> am <input type="checkbox"/> pm <b>OR</b>				6. Period of exposure resulting in occupational disease (yyyy-mm-dd) From _____ To _____			
7. Did worker report injury or exposure to employer? <input type="checkbox"/> Yes <input type="checkbox"/> No				8. The injury or disease was first reported to employer on (yyyy-mm-dd)				(please check one) To: <input type="checkbox"/> First aid <input type="checkbox"/> Supervisor <input type="checkbox"/> Office <input type="checkbox"/> Other (specify)			
9. Name of person reported to											
10. Describe how the incident happened						11. Describe the injury in detail (what part of the body was injured)					
						12. Side of body injured <input type="checkbox"/> Left <input type="checkbox"/> Right <input type="checkbox"/> Both <input type="checkbox"/> Not applicable					
13. Describe the work incident location (address, city, province) and where incident occurred (e.g. shop floor, lunchroom, parking lot)											
14. Did the injury(ies) or exposure result from a specific incident? <input type="checkbox"/> Yes <input type="checkbox"/> No											





If faxing form, please complete this section and fax both sides of page. Missing pages may result in delays in processing.

Worker last name		First name		Middle initial	WorkSafeBC claim number (if known)
Social insurance number	Personal health number (CareCard)		Date of incident (yyyy-mm-dd)		Date of birth (yyyy-mm-dd)

15. Contributing factors — select **at least one**, and as many as applicable

<input type="checkbox"/> Lifting	<input type="checkbox"/> lb	<input type="checkbox"/> kg	<input type="checkbox"/> Struck	<input type="checkbox"/> Assault
<input type="checkbox"/> Overexertion			<input type="checkbox"/> Crush	<input type="checkbox"/> Motor vehicle accident
<input type="checkbox"/> Repetitive (activity repeated over and over again)			<input type="checkbox"/> Sharp edge	<input type="checkbox"/> Unsure/other (please explain below)
<input type="checkbox"/> Slip or trip			<input type="checkbox"/> Fire or explosion	
<input type="checkbox"/> Twist			<input type="checkbox"/> Harmful substances in the work environment	
<input type="checkbox"/> Fall			<input type="checkbox"/> Animal bite	

16. Were there any witnesses?  
 Yes  No

17. Did the incident occur in British Columbia?  
 Yes  No

18. Were the worker's actions at time of injury for the purpose of your business?  
 Yes  No

19. Did the incident occur on employer's premises or an authorized worksite?  
 Yes  No

20. Did the incident happen during the worker's normal shift?  
 Yes  No

21. Was the worker performing their regular duties at the time of the incident?  
 Yes  No

22. Did the worker receive first aid?  
 Yes  No Date (yyyy-mm-dd) ▶

If yes, please provide first aid attendant name (if known)

23. Did the worker go to hospital, clinic, or visit a physician or qualified practitioner?  
 Yes  No Date (yyyy-mm-dd) ▶

If yes, please provide provider name (if known)

If yes, please provide provider address (if known)

24. Are you aware of any recent pain or disability in the area of the worker's reported injury?  
 Yes  No

25. Do you have any objections to the claim being allowed?  
 Yes  No ▶

If yes, please explain

**Wage information**

26. Did the worker miss any time from work beyond the date of injury or exposure?  
 Yes  No

**If no work was missed and no change to duties/pay, proceed to bottom of page to sign, date, and submit this report.**  
**If work was missed or if duties/pay have been modified, please answer all questions on this form.**

27. Provide the **base salary** amount for this employment position at the time of injury  
\$ \_\_\_\_\_  Hourly  Daily  Weekly  Monthly  Yearly

28. Does worker receive other amounts of compensation in addition to **base salary**?  Yes  No  
Does worker receive vacation pay on every cheque?  Yes  No  
If yes, vacation pay \_\_\_\_\_%

29. If worker is disabled from work, will you continue to pay:  Yes  No  
**Base salary?**  Yes  No  
Other amounts of compensation in addition to **base salary**?  Yes  No  
Will worker receive vacation pay on every cheque?  Yes  No  
If yes, vacation pay \_\_\_\_\_%

Please select check boxes for any of the following amounts worker receives in addition to **base salary** AND provide the amount for each:

<input type="checkbox"/> Tips and gratuities \$ _____	<input type="checkbox"/> Room and board \$ _____
<input type="checkbox"/> Shift differential \$ _____	<input type="checkbox"/> Other \$ _____
<input type="checkbox"/> Overtime \$ _____	

Please select check boxes for any of the following amounts worker will continue to receive in addition to **base salary** AND provide the amount for each:

<input type="checkbox"/> Tips and gratuities \$ _____	<input type="checkbox"/> Room and board \$ _____
<input type="checkbox"/> Shift differential \$ _____	<input type="checkbox"/> Other \$ _____
<input type="checkbox"/> Overtime \$ _____	

30. Provide the amount of **gross** earnings for the past 3 months or 12 weeks prior to the date of injury or exposure  
\$ \_\_\_\_\_  3 months  12 weeks

31. Does the worker have a fixed-shift rotation?  Yes  No

32. If no, please explain

33. If yes, show the normal work week by entering the paid hours

Sun	Mon	Tues	Wed	Thu	Fri	Sat

34. Did the worker continue to work past day of injury?  
 Yes  No

35. Last day worked (yyyy-mm-dd)

36. Number of hours scheduled to work on last day worked

37. Number of hours worked on last day

38. Number of hours paid by employer on last day worked





If faxing form, please complete this section and fax both sides of page. Missing pages may result in delays in processing.

Worker last name				First name				Middle initial		WorkSafeBC claim number (if known)					
Social insurance number				Personal health number (CareCard)				Date of incident (yyyy-mm-dd)				Date of birth (yyyy-mm-dd)			

**Return-to-work information**

39. Has the worker returned to work? <input type="checkbox"/> Yes <input type="checkbox"/> No	
40. If <b>Yes</b> : Date (yyyy-mm-dd) Since the return to work, have the worker's duties, hours of work, work schedule, and/or rate of pay changed? <input type="checkbox"/> Yes <input type="checkbox"/> No	
41. If <b>No</b> : Do you have any modified or transitional duties available? <input type="checkbox"/> Yes <input type="checkbox"/> No Have the modified or transitional duties been offered to the worker? <input type="checkbox"/> Yes <input type="checkbox"/> No	42. If yes, please describe modified or transitional duties

**Signature and report date**

43. Employer signature	44. Employer title	45. Date of report (yyyy-mm-dd)
------------------------	--------------------	---------------------------------

**For assistance**, please call our Claims Call Centre at 604.231.8888 or toll-free within Canada at 1.888.967.5377, M-F, 8:00 a.m. to 6:00 p.m.

**Please note:** If you have concerns with this claim, please contact the officer handling the claim at the WorkSafeBC office to make known your objections or you may submit a letter detailing your specific concerns. **Impartial advice on WorkSafeBC claims** — To ensure you have an opportunity to obtain impartial advice on WorkSafeBC claims matters, the BC legislature has provided impartial advisers. **Employers' Advisers** are available to provide independent advice or clarification on a WorkSafeBC claim related to your firm. For additional information on the Employers' Advisers, please refer to their website at [www.labour.gov.bc.ca/eao](http://www.labour.gov.bc.ca/eao) or email: [eao@eao-bc.org](mailto:eao@eao-bc.org)

**Toll-free within Canada:**  
1.800.925.2233

**Employers' Adviser Office locations:**  
Richmond, Langley, Kamloops, Kelowna, Nanaimo, Trail, Prince George, Victoria.

WorkSafeBC collects information on this form for the purposes of administering and enforcing the Workers Compensation Act. That Act, along with the Freedom of Information and Protection of Privacy Act, constitutes the authority to collect such information. To learn more about the collection of personal information, contact WorkSafeBC's FIPP Office, at PO Box 2310 Stn Terminal, Vancouver BC, V6B 3W5, or email [FIPP@worksafebc.com](mailto:FIPP@worksafebc.com), or call 604.279.8171.



## Worker's information

Worker's last name	First name	Middle initial	WorkSafeBC claim number	Social insurance number
Preferred first name		Personal health number (BC Services Card/CareCard)		Date of birth (yyyy-mm-dd)
Address		City	Province	Postal code
Email address		Phone number (please include area code)		

## Employer's information

Employer name (as registered with WorkSafeBC)	Phone number (please include area code)			
Address	City	Province	Postal code	

## Details of injury

Worker's occupation	Date of injury (yyyy-mm-dd)	Location of plant or project where injury occurred	Postal code
Date worker was first laid off work (yyyy-mm-dd)		Time <input type="checkbox"/> a.m. <input type="checkbox"/> p.m.	
Has worker returned to work? <input type="checkbox"/> Yes <input type="checkbox"/> No	If yes, what date? (yyyy-mm-dd)	Time <input type="checkbox"/> a.m. <input type="checkbox"/> p.m.	
Did this employee work between first time off and final return or recovery? <input type="checkbox"/> Yes <input type="checkbox"/> No	If yes, please give dates From _____ to _____		
Did worker return to work as soon as possible? (please give your opinion)			
Or if not returned to work, is the worker able to do so? (please give your opinion)			
On what date do you consider the worker was first able to return to work? (yyyy-mm-dd)		Time <input type="checkbox"/> a.m. <input type="checkbox"/> p.m.	
How many working days or shifts did the worker miss? <input type="checkbox"/> Days <input type="checkbox"/> Shifts			
Is the worker earning or able to earn as much as before the injury? <input type="checkbox"/> Yes <input type="checkbox"/> No	Now earning (\$ per week)	If not, how much has the injury reduced the earnings? (\$ per week)	

# Employer's Statement of Return to Work

Worker's last name	First name	Middle initial	WorkSafeBC claim number
--------------------	------------	----------------	-------------------------

How long is this impairment of earning capacity likely to continue?

Have you paid or allowed the worker anything for the period of disability?

Yes     No

If yes, please give particulars

Total amount (\$)

Are there any peculiar circumstances or conditions about this case?

Yes     No

If yes, please state them

Employer's signature	Title	Date (yyyy-mm-dd)
----------------------	-------	-------------------

### Additional information

### How to submit your form

**Online is the quickest and easiest method!** Complete this fillable form and add your electronic signature, then visit [worksafebc.com/claims-uploader](https://worksafebc.com/claims-uploader) to submit the electronic document to the worker's claim file.

**Fax:** 604.233.9777 (toll-free at 1.888.922.8807) | **Mail:** WorkSafeBC, PO Box 4700 Stn Terminal, Vancouver, BC, V6B 1J1

**For further assistance:** Claims Call Centre, 604.231.8888 (toll-free at 1.888.967.5377), M–F, 8 a.m. to 6 p.m.

WorkSafeBC collects information on this form for the purposes of administering and enforcing the *Workers Compensation Act*. That Act, along with the *Freedom of Information and Protection of Privacy Act*, constitutes the authority to collect such information. To learn more about the collection of personal information, contact WorkSafeBC's FIPP Office at PO Box 2310 Stn Terminal, Vancouver, BC, V6B 3W5, or email [FIPP@worksafebc.com](mailto:FIPP@worksafebc.com), or call 604.279.8171.